

# **fuel effects on the characteristics of particle emissions from advanced engines and vehicles**

Prepared for the CONCAWE Fuels quality and Emissions Management Group by its  
Special Task Force FE/STF-10:

R. Carbone  
A. Jørgensen  
N. Ranchet  
D.J. Rickeard  
C.J. Rowntree  
R.J. Stradling  
P.J. Zemroch

D.E. Hall (Consultant)

N.D. Thompson (Technical Coordinator)

Reproduction permitted with due acknowledgement

© CONCAWE  
Brussels  
January 2005

## ABSTRACT

To update understanding on emissions from road transport, CONCAWE is continuing to assess fuel effects on emissions from new engine/vehicle technologies as they approach the market. In this work, two advanced light-duty diesel vehicles, two direct injection gasoline vehicles, and three heavy-duty diesel engines covering Euro-3 to Euro-5 technologies were tested on a range of fuels.

This report concentrates on the fuel and engine technology effects observed on a range of individual characteristics of the particulate emissions, measured as part of CONCAWE's contribution to the larger DG TREN 'Particulates' Consortium. In addition to regulated mass, the total number, surface area and size distribution of the particulate emissions have also been measured.

Results for regulated emissions and fuel consumption for the diesel engines and vehicles are described in the companion CONCAWE report 2/05 [1].

## KEYWORDS

exhaust emissions, diesel, diesel fuel, diesel engine, engine technology, vehicle technology, fuel quality, euro-3, euro-4, euro-5, particles, particulates, nucleation, accumulation, size distribution, surface area

## INTERNET

This report is available as an Adobe pdf file on the CONCAWE website ([www.concaawe.org](http://www.concaawe.org)).

### NOTE:

*Considerable efforts have been made to assure the accuracy and reliability of the information contained in this publication. However, neither CONCAWE nor any company participating in CONCAWE can accept liability for any loss, damage or injury whatsoever resulting from the use of this information.*

*This report does not necessarily represent the views of any company participating in CONCAWE.*

<b>CONTENTS</b>		<b>Page</b>
<b>1.</b>	<b>INTRODUCTION</b>	<b>1</b>
<b>2.</b>	<b>ENGINES/VEHICLES SELECTION</b>	<b>3</b>
2.1.	HEAVY-DUTY ENGINES	3
2.2.	LIGHT-DUTY VEHICLES	4
2.2.1.	Diesel vehicles	4
2.2.2.	Gasoline Vehicles	5
<b>3.</b>	<b>TEST FUELS</b>	<b>6</b>
3.1.	DIESEL FUELS	6
3.2.	GASOLINE FUELS	8
3.3.	LUBRICANT SELECTION	8
<b>4.</b>	<b>TEST METHODOLOGY</b>	<b>9</b>
4.1.	TEST CYCLES AND DAILY PROTOCOL	9
4.2.	PARTICULATE CHARACTERISATION	11
<b>5.</b>	<b>DATA HANDLING AND STATISTICAL ANALYSIS</b>	<b>13</b>
5.1.	DATA HANDLING	13
5.2.	DATA VALIDATION	13
5.3.	STATISTICAL ANALYSIS	14
<b>6.</b>	<b>TEST RESULTS AND DISCUSSION - GENERAL</b>	<b>16</b>
6.1.	HEAVY-DUTY ENGINES	16
6.1.1.	Regulated particulate mass (PM) emissions	16
6.1.2.	Total number of carbonaceous particles	17
6.1.3.	Total particle count	19
6.1.3.1.	Steady-state data	20
6.1.3.2.	Transient data	24
6.1.4.	ASMO – total surface area	26
6.2.	LIGHT-DUTY DIESEL VEHICLES	27
6.2.1.	Particulate Mass emissions	27
6.2.1.1.	Filter Paper	27
6.2.1.2.	Gravimetric Impactor (DGI) data	29
6.2.2.	Total number of carbonaceous particles	30
6.2.3.	Total particle count	32
6.2.3.1.	Transient testing	32
6.2.3.2.	Steady-state testing	33
6.2.4.	ASMO – Total surface area	38
6.3.	LIGHT-DUTY GASOLINE VEHICLES	38
6.3.1.	Particulate mass	38
6.3.2.	Total number of carbonaceous particles	40
6.3.3.	Total particle count	41
6.3.3.1.	Transient data	41
6.3.3.2.	Steady-state Data	43
6.3.4.	ASMO – total surface area	45
6.4.	INSTRUMENT REPEATABILITY	46

<b>7.</b>	<b>CONCLUSIONS AND IMPLICATIONS</b>	<b>48</b>
<b>8.</b>	<b>GLOSSARY</b>	<b>50</b>
<b>9.</b>	<b>ACKNOWLEDGEMENTS</b>	<b>52</b>
<b>10.</b>	<b>REFERENCES</b>	<b>53</b>
<b>APPENDIX 1</b>	<b>ARTEMIS “REAL WORLD” DRIVE CYCLES</b>	<b>56</b>
<b>APPENDIX 2</b>	<b>MEAN EMISSIONS DATA, GASOLINE CARS</b>	<b>58</b>
<b>APPENDIX 3</b>	<b>STATISTICAL DATA ANALYSIS</b>	<b>59</b>

## SUMMARY

The introduction of increasingly stringent exhaust emissions legislation has required the development of advanced (and more catalytically active) exhaust after-treatment technologies. Some of these devices will only work satisfactorily with low sulphur or sulphur-free fuel, which is now being introduced across Europe. As cleaner fuels and vehicles are introduced, the potential for further improvements in air quality through additional changes to fuel properties can be expected to diminish. Nevertheless, CONCAWE is continuing to update knowledge by evaluating fuel effects on emissions from new engine/vehicle technologies as they approach the market.

This report concentrates on the work carried out as CONCAWE's contribution to the DG TREN "Particulates" consortium [2] and especially on the particulate characterisation that was undertaken during that study. Two advanced light-duty diesel vehicles, two direct injection gasoline vehicles, and three heavy-duty diesel engines covering Euro-3 to Euro-5 technologies were tested over a matrix of fuels that covered a range of sulphur content. For diesel fuels, comparisons were also made between conventional fuels and extreme fuel compositions such as Swedish Class 1, Fischer-Tropsch diesel fuel and a 5% RME<sup>1</sup> blend. The regulated emissions measured during this programme have been analysed and presented separately [1,3].

Measurement instruments were used which provided information on the number, mass, surface area and size distribution of the particles, in addition to the filter paper mass method currently specified in the diesel emission regulations. Exhaust particulates may be categorised as 'accumulation mode' – larger particles based on a carbon core – and smaller 'nucleation mode' particles that are composed primarily of condensed sulphate and hydrocarbon material. One of the objectives of the "Particulates" programme was to generate data to give a better understanding of the nucleation mode. To achieve this, most of the measurements were made using a specially developed dilution technique which enabled measurement of 'wet' particles, including both carbonaceous and condensed liquid components. Measurements were also made after passing the diluted exhaust through a thermodenuder to remove volatile material, allowing a count of the dry carbonaceous particles to be made.

The work has clearly demonstrated the benefits of diesel particulate filters in combination with low sulphur fuels on both particulate mass and number emissions. Diesel particulate filters with low sulphur fuels have the potential to reduce particulate mass emissions by more than an order of magnitude and number emissions by several orders of magnitude. A prototype Euro-5 engine with NO<sub>x</sub> reduction by SCR but without a particulate filter was shown to reduce particulate mass emissions, but to have less impact on particle number emissions. The effect of diesel fuel sulphur was greatest under high temperature operation. Under these conditions, lower sulphur fuels reduced particle mass and number emissions. In absolute terms, fuel effects other than sulphur were small with the advanced engine technologies.

---

<sup>1</sup> A full glossary of acronyms used in this report is given in **Section 8**.



## 1. INTRODUCTION

Health effects of particulate emissions from road transport have been of interest for many years. Particulate emissions from vehicles have generally been controlled via legislation based on particulate mass. Recent studies have however suggested that adverse health effects may not only be dependent on total particulate mass, but on other metrics including size, number and surface area. Smaller particles have been claimed by some to cause more adverse effects than large particles. This has led to revision of the particulates Air Quality Standard in the U.S.A to include measurement of finer particulates ( $PM_{10} \rightarrow PM_{2.5}$ ) and to further evaluation of the best metric for air quality standards worldwide. Within the European Clean Air For Europe (CAFE) programme, the recommendation from the Particulate Working group is to adopt  $PM_{2.5}$  as the European Air Quality metric. In Europe, further tightening of controls on particulate emissions from vehicles is already enacted in the form of Euro-3 and Euro-4 standards for light-duty vehicles and Euro-3, 4, and 5 standards for heavy-duty engines [4,5]. Discussions on further steps, Euro-5 for light-duty vehicles and Euro-6 for heavy-duty engines are already underway.

Alongside the reduction in particulate mass emissions from vehicles, measurement methodologies are being enhanced to improve the accuracy of the measurement at these very low emissions levels. Additionally, there has been a focus on the development of methodologies to measure the size and number of particulate emissions as well as mass. It is now generally accepted that automotive particle emissions fall into two broad categories:

- “Accumulation” mode particles, mainly carbonaceous in nature and greater than ca. 30 nm in particle size,
- “Nucleation” mode particles, generally below 30 nm particle size, comprising predominantly condensed volatile material; mainly sulphate and heavy hydrocarbons.

The presence of nucleation mode particles has been related to the concentration of carbon and hydrocarbons in the exhaust. Where significant amounts of carbon are emitted in the exhaust, volatile sulphates and hydrocarbons tend to condense onto these existing particles. Under conditions where carbon emission is reduced, there is a tendency for hydrocarbons and particularly sulphates to condense independently, forming large numbers of very small nucleation mode particles. The extent of this nucleation mode formation has been shown to be dependent on engine and fuel technology, the use of after-treatment, operating conditions and also strongly linked with sampling and measurement conditions [6].

The “Particulates” Consortium [2] was established to develop further knowledge on particulate emissions from motor vehicles, especially in terms of characterisation of particulate size and number emissions with current and future vehicles and fuels. It was set-up as part of the ARTEMIS project cluster [7] which aimed to update emissions factors for regulated pollutants from road transport. The main aims of “Particulates” were:

- to increase knowledge and understanding of particulate emissions from motor vehicles,
- to provide a harmonised particulate sampling and measurement methodology,
- to provide input on representative emissions factors for particulates to enhance air quality modelling tools and help explain health effects,

- to assess the effectiveness of technical measures for reducing particulate emissions.

A critical first step in the “Particulates” programme was the definition of the exhaust aerosol properties to be examined and the identification of suitable instruments and measurement techniques to be used. A major decision of the Consortium was to measure both accumulation mode and nucleation mode particles, under transient as well as steady-state conditions. The nucleation mode particles presented a major challenge as they were known to be highly sensitive to test and sampling conditions. Following a review of available instrumentation and an investigation of a range of sampling techniques, a harmonised sampling and testing methodology was developed (described in detail in **Section 4.2**) and used throughout the test work.

The engines and vehicles tested by the many different partners in the Consortium covered a wide range of technologies (with respect to engine, fuel and after-treatment) and are detailed elsewhere [8,9]. CONCAWE contributed directly to the programme, testing two advanced light-duty diesel vehicles (Euro-3), two direct injection gasoline vehicles (Euro-3) and three heavy-duty diesel engines covering Euro-3 to Euro-5 technologies. Seven diesel fuels were tested, covering a range of sulphur content and compared conventional fuels with extreme fuel compositions such as Swedish Class 1, Fischer-Tropsch fuel and a 5% RME blend. Three gasoline fuels were tested covering a range of sulphur content.

This report describes the results of particulate characterisation for the fuels and vehicles tested in the CONCAWE work. Regulated emissions measured in the CONCAWE diesel tests have been analysed and reported separately [1,3].



## 2. ENGINES/VEHICLES SELECTION

### 2.1. HEAVY-DUTY ENGINES

The heavy-duty test engines were selected to cover the range of technologies likely to be used to meet Euro-3, Euro-4 and Euro-5 exhaust emissions standards. The Euro-3 engine was an existing market technology without after-treatment. As Euro-4 and Euro-5 engines were not yet available in the market, prototype systems developed at AVL were used. The prototype Euro-4 engine used a combined system of EGR plus a Continuously Regenerating Trap (CRT). The prototype Euro 5 engine used SCR/urea, together with engine modifications to optimise engine out NOx/PM. These two approaches represented those considered at the time to be most likely to be used to meet the advanced EU emissions standards. Further technical details on the engines are given in **Table 1**:

**Table 1** Heavy-duty engine specification data

	<b>Euro-3</b>	<b>Euro-4</b>	<b>Euro-5</b>
<b>Certification level</b>	Production Euro-3	AVL prototype Euro-4	AVL prototype Euro-5
<b>Cylinders</b>	6	6	6
<b>Displacement (dm<sup>3</sup>)</b>	12	11	12
<b>Max Torque [Nm] @ rpm [min-1]</b>	2019 @ 1200	1865 @ 1200	1894 @ 1300
<b>Max Power [kW] @ rpm [min-1]</b>	300 @ 1800	300 @ 1900	300 @ 1800
<b>Valves per cylinder</b>	4	4	4
<b>Fuel injection equipment</b>	Unit injectors	Unit injectors	Unit injectors
<b>Aspiration</b>	TC	TC	TC
<b>EGR</b>	No	Cooled EGR	No
<b>Exhaust after- treatment</b>	None	CRT	SCR / urea

## 2.2. LIGHT-DUTY VEHICLES

### 2.2.1. Diesel vehicles

Two diesel passenger cars were selected for testing representing advanced technologies available in the European market in 2002. These included a medium sized DI diesel car with an oxidation catalyst and a large DI diesel car with a particulate filter system which regenerated with the aid of a fuel-borne catalyst. More details on the main technical characteristics of the engines are reported in **Table 2**.

**Table 2** Light-duty diesel vehicle specification data

Vehicle Type	Car A	Car B
Displacement (cm <sup>3</sup> )	1896	2179
Max. Power (kW @ rpm)	74 @ 4000	98 @ 4000
No. of Cylinders	4	4
Max. Torque (Nm @ rpm)	240 @ 1800	314 @ 2000
Compression Ratio	19	17.6
Aspiration	TC	TC
Intercooler Y (yes) N (no)	Y	Y
Combustion Type	DI	DI
Injection System	Unit injectors	Common Rail
EGR Y (yes) N (no)	Y	Y
Exhaust after-treatment	Oxidation catalyst	Additised DPF
Model Year	2002	2001
Certification level	Euro-3	Euro-3

## 2.2.2. Gasoline Vehicles

It has been established by previous studies [6] that direct injection gasoline vehicles (DISI) emit more particles than conventional gasoline vehicles. These particles have chemical and physical characteristics approaching those emitted from Diesel engines. Consequently, it was decided to include two DISI vehicles in this study, one stoichiometric and one lean burn. Specification data for these vehicles are given in **Table 3**.

**Table 3** Light-duty gasoline vehicle specification data

Vehicle Type	Car C	Car D
Displacement (cm <sup>3</sup> )	1998	1997
Max. Power (kW @ rpm)	103 @ 5500	107 @ 6000
Inertia class (kg)	1250	1470
No. of cylinders	4	4
Valves per cylinder	4	4
Max. Torque (Nm @ rpm)	200 @ 4250	193 @ 4100
Compression Ratio	10.0:1	11.4:1
Combustion / Injection system	Stoichiometric DISI	Lean DISI
Exhaust after-treatment	TWC	TWC + NOx trap
Model Year	2001	2002
Certification level	Euro-3	Euro-3

### 3. TEST FUELS

The core test fuels were selected based on the objectives to develop representative emissions factors for current and future vehicle fleets as well as to enhance understanding of fuel effects. Existing knowledge [10] indicated fuel sulphur as a key fuel effect on particle emissions, both in terms of enabling new exhaust after-treatment technology and as a direct effect on sulphate emissions.

In view of the importance of fuel sulphur in enabling advanced exhaust after-treatment systems, the recent update to the EU Fuels Directive [11] requires 50 mg/kg max sulphur content in both gasoline and diesel fuels from 2005, with “appropriate geographic availability” of sulphur-free fuels (10 mg/kg max sulphur content) from the same date, progressing to 100% coverage of sulphur free fuels by 2009 (this date being subject to a further review for diesel). No other fuel property changes are required for 2005, except for the already agreed reduction in gasoline aromatics to 35% v/v max.

#### 3.1. DIESEL FUELS

Test fuels D2 to D4 were designed to study the sulphur effect, using a base fuel with sulphur content as low as possible and with other properties held as close as possible to average year 2000/05 levels. Sulphur levels were adjusted by doping the base fuel (D4) with di-tertiarybutyl-di-sulphide, to cover the range from current sulphur levels to the projected sulphur-free case. The target levels for the other fuel properties were derived from work on the reference fuel specifications for 2005 and beyond.

Additional fuels were included to assess the largest possible range of fuel properties. These included two additional sulphur-free fuels with extremely low density and aromatics content: Swedish Class 1 diesel fuel and Fischer-Tropsch diesel fuel. A 5% RME blend, produced from fuel D4, was also tested. A second diesel fuel at the current (year 2000) sulphur level but with higher density and aromatics content was also included in the test matrix.

**Table 4** shows the analytical data for the test fuels.

**Table 4** Diesel Fuel Analyses

Fuel Code			D2 to D4	D5	D6	D7	D8
Fuel Description	Units	Test method	Sulphur Matrix	Swedish Class 1	EN590: pre-2000	5% RME in D4	Fischer Tropsch
Cetane Number		D 613	54.0	55.1	46.5	54.5	>75
Cetane Index		IP 380	51.1	51.7	46.7	50.6	*
Density	kg/m <sup>3</sup>	EN ISO 3675	845	810	856	846	785
T50	°C	EN ISO 3405	282	226	279	284	298
T95	°C	EN ISO 3405	358	282	366	358	349
FBP	°C	EN ISO 3405	368	294	373	367	355
CFPP	°C	EN 116	-33	-39	-14	-33	0
KV @ 40°C	mm <sup>2</sup> /s	EN ISO 3104	3.04	1.79	3.15	3.08	3.61
Poly-aromatics	% m/m	IP 391	4.3	<0.1	7.3	5.0	0.0
Mono-aromatics	% m/m	IP 391	14.1	1.7	31.0	12.9	0.1
Carbon	% m/m		86.8	85.7	87.1	86.3	85.0
Hydrogen	% m/m		13.2	14.3	12.9	13.1	15.0
H:C ratio	atomic ratio		1.82 : 1	2.00 : 1	1.78 : 1	1.82 : 1	2.12: 1
LHV	MJ/kg		42.87	43.63	42.69	42.70	44.17
Lubricity	µm	HFRR	375	386	389	237	279
FAME	% v/v		Nil	Nil	Nil	5	Nil
Sulphur	mg/kg	D 3120/2622		<5**	307	7	<5**
<b>D2</b>	<b>EN 590 : 2000</b>		<b>280</b>				
<b>D3</b>	<b>EN 590 : 50 ppm S</b>		<b>38</b>				
<b>D4</b>	<b>EN 590 : 10 ppm S</b>		<b>8</b>				

\* Cetane index equation is not applicable to FT diesel fuel.

\*\* Below detection limit

### 3.2. GASOLINE FUELS

Again, the test fuels were mainly designed around the sulphur effect, using base fuels with other properties held as close as possible to average year 2000/05 levels, but with as low a sulphur content as possible. Sulphur levels were adjusted to typical current, 2005 and 2009 levels by doping with thiophene. The target levels for the base fuel properties were derived from work on the development of reference fuel specifications for 2005 and beyond, and should therefore provide a firm basis for the development of emissions factors. Analytical data are given in **Table 5**.

**Table 5** Gasoline Analyses

Fuel Code			<b>G1</b>	<b>G2</b>	<b>G3</b>
Fuel Description	Units	Test method	<b>EN 228: Year 2000</b>	<b>EN 228: 50 ppm S</b>	<b>EN 228: 10 ppm S</b>
Characteristic			<b>Result</b>	<b>Result</b>	<b>Result</b>
RON		ISO 25164	<b>96.4</b>	<b>96.8</b>	<b>96.8</b>
MON		ISO 25163	<b>85.3</b>	<b>86.0</b>	<b>86.0</b>
Density	kg/m <sup>3</sup>	EN ISO 3675	<b>753</b>	<b>749</b>	<b>748</b>
DVPE	kPa	EN ISO 13016	<b>58.7</b>	<b>57.7</b>	<b>57.7</b>
E70	% v/v	EN ISO 3405	<b>29.4</b>	<b>32.5</b>	<b>32.5</b>
E100	% v/v	EN ISO 3405	<b>50</b>	<b>51.2</b>	<b>51.2</b>
E150	% v/v	EN ISO 3405	<b>85.5</b>	<b>86.1</b>	<b>86.1</b>
FBP	°C	EN ISO 3405	<b>195</b>	<b>193</b>	<b>193</b>
Residue	% v/v	EN ISO 3405	<b>1.0</b>	<b>1.1</b>	<b>1.1</b>
Olefins	% v/v	D 1319	<b>8.8</b>	<b>9.9</b>	<b>9.9</b>
Aromatics	% v/v	D 1319	<b>35.4</b>	<b>33.4</b>	<b>33.4</b>
Benzene	% v/v	EN 12177:98	<b>0.8</b>	<b>0.6</b>	<b>0.6</b>
Sulphur	mg/kg	D 3120/2622	<b>143</b>	<b>45</b>	<b>6</b>
Lead	mg/l	EN 237	<b>&lt;1</b>	<b>&lt;1</b>	<b>&lt;1</b>
Phosphorus	mg/l		<b>&lt;1</b>	<b>&lt;1</b>	<b>&lt;1</b>
Carbon	% m/m	D 5291	<b>86.3</b>	<b>86.0</b>	<b>86.0</b>
Hydrogen	% m/m	D 5291	<b>13.0</b>	<b>13.2</b>	<b>13.2</b>
Oxygen	% m/m		<b>0.7</b>	<b>0.8</b>	<b>0.8</b>

### 3.3. LUBRICANT SELECTION

A common batch of lubricant was used for the programme in order to minimise effects from differing lubricants. The lubricant was selected as being representative of current typical European lubricant quality, i.e. a conventional mineral oil formulation meeting: SAE 15W-40, ACEA Class A3 / B3 for light-duty, ACEA Class E3 for heavy-duty, with a sulphur content of 0.6% m/m. This oil was suitable for use in both gasoline and light-duty and heavy-duty diesel engines.

## 4. TEST METHODOLOGY

### 4.1. TEST CYCLES AND DAILY PROTOCOL

The details on the driving cycles used for the tests were those prescribed by Deliverable 5 from the “Particulates” Consortium’s Work Package 400 [12]. In all cases the standard legislative emissions test cycles for light-duty vehicles and heavy-duty engines were used [4,5]. These were supplemented by some “real world drive cycles” (**See Appendix 1**) which were developed under the ARTEMIS programme [7] and several steady-state conditions. Light-duty vehicle tests were conducted by Shell Global Solutions and heavy-duty engine tests by AVL.

For heavy-duty engines, the relevant legislative heavy-duty engine emissions test cycles, ESC and ETC tests, were used, together with a series of extended steady-state modes covering both on-cycle and off-cycle measurement points. A common test sequence was required in order to obtain comparable results from different fuel/engine combinations. This general daily test sequence was :

#### ***Heavy-duty Engine Test Sequence***

- Warm-up (Road load, followed by 0.5 h at full load, rated speed)
- Dummy ESC
- ESC (full load points at full rack, part load points at constant torque for each fuel)
- ETC (full load points at full rack, part load points at constant torque for each fuel)
- Extended Steady-states - Range of on- and off-cycle conditions as below:
  - SS1 - ECE R-49 Mode 2
  - SS2 - ESC Mode 5 (50% load, speed A)
  - SS3 - ESC Mode 12 (75% load, speed C)
  - SS4 - Road load, speed 50/50 A/C
  - SS5 - 25% load, speed A-10%
  - SS6 - 50% load, 50% speed

For light-duty vehicles, the following basic daily test sequence was used:

**Light-duty Vehicle Test Sequence**

- Fuel change
- Conditioning : Diesel cars 3\* EUDC, Gasoline cars 1\*ECE + 2\*EUDC
- Cold soak
- NEDC test
- Hot start NEDC test
- ARTEMIS urban test
- ARTEMIS road test
- ARTEMIS motorway test (130 km/h max speed)
- Steady-state tests : 50 and 120 km/h
- End of test

The test programme was constructed using the principles of statistical experimental design. Fuels were tested three times in each vehicle/engine, based on a randomised block design. Each fuel was tested once in each block of tests, minimising the risk of fuel comparisons being contaminated by any drift in vehicle performance or other time-related effects. Repeat tests on a fuel were not conducted back-to-back to ensure that the results were truly independent.

All fuels were tested in the light-duty vehicles. In the heavy-duty engines, the 300 ppm sulphur fuels were not considered relevant to test in the Euro-4 or Euro-5 engines, likewise the Fischer-Tropsch diesel was not tested in the Euro-3 engine. The actual diesel engine/vehicle/fuel combinations tested are given in **Table 6**.

**Table 6** Diesel engine/vehicle/fuel combinations tested

	Fuel Code						
	D2	D3	D4	D5	D6	D7	D8
<b>LIGHT-DUTY Vehicles</b>							
<b>Car A</b>	√	√	√	√	√	√	√
<b>Car B</b>	√	√	√	√	√	√	√
<b>HEAVY-DUTY Engines</b>							
<b>Euro-3</b>	√	√	√	√	√	√	
<b>Euro-4</b>		√	√	√		√	√
<b>Euro-5</b>		√	√	√		√	√



## 4.2. PARTICULATE CHARACTERISATION

One of the main objectives of the test protocol was to examine the emissions of nucleation particles, alongside the more robust carbonaceous particles. It is known that such particles are produced under real-world operating conditions, however current theory suggests that dilution via a CVS does not generally provide conditions suitable for the formation of nucleation particles [13]. Extensive preliminary work [14] was carried out and from this a proposal for an alternative approach was tabled, along with a controlled set of test conditions, under which the formation of nucleation particles had been observed. The finalised test system [15,16] is shown in **Figure 1**.

**Figure 1** Diagram of 'PARTICULATES' Measuring System

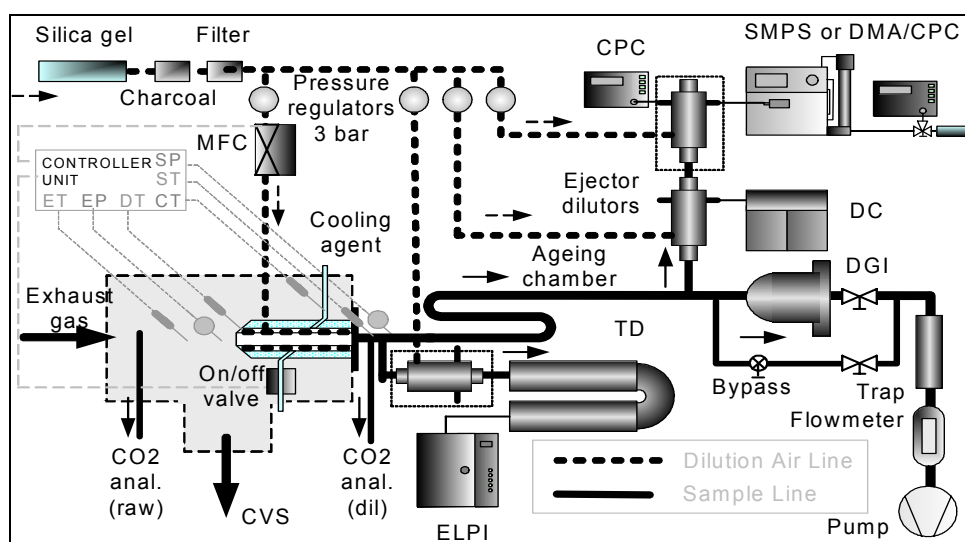

A sample of raw exhaust gas was drawn into a porous tube diluter (at fixed dilution conditions: DR 12.5:1; temperature of 32°C; humidity <5%). The aerosol was then divided with one portion passed through a thermodenuder (TD) to remove volatile material and thus allow measurements of carbon particles (accumulation mode) only. These particles were referred to as the 'dry' branch and they were quantified using an ELPI, which allowed a size distribution (number weighted) to be measured along with a total particle count. The second portion of aerosol (called the 'wet' branch and inclusive of both accumulation and nucleation particles) was allowed to stabilise in an ageing chamber, and was then characterised in more detail. The measurements made are detailed in **Table 7**. Regulated particulate mass was measured according to legislative procedures, with the same approach applied to the particulate mass emissions from the gasoline vehicles, even though these emissions are not legislated.

**Table 7** Summary of particulate measurements made during testing

Test condition	Measurement	Equipment	Wet or dry branch
<b>Transient</b>	Total particle count (plus modal production)	CPC, TrDMPS (HD only)	Wet
	Total count of carbonaceous particles (plus modal production)	ELPI	Dry
	Total surface area	ASMO	Wet
	Size distribution (mass)	DGI	Wet
	Particulate mass	Filter	*
<b>Steady-state</b>	Total particle count	CPC	Wet
	Total count of carbonaceous particles (plus distribution by number)	ELPI	Dry
	Total surface area	ASMO	Wet
	Size distribution (mass)	DGI	Wet
	Size distribution (number)	SMPS, DDMPS (HD only)	Wet
	Particulate mass	Filter	*

\* Direct sampling from CVS for light-duty vehicles.  
 Partial flow dilution from raw exhaust using AVL smart-sampler for heavy-duty engines.

For the heavy-duty test work, the same basic principles were applied. However, testing for the Euro-3 engine at AVL did not include measurements of surface area and no mass distribution data were measured for any heavy-duty engine. Two additional pieces of equipment were used however; the DDMPS [17] for steady-state testing and the TrDMPS [18] which permits full size characterisation of the particulates emitted whilst the engine is running under transient conditions. Further information on the particulate size ranges measured by the various techniques is given in **Table 8** below.

**Table 8** Particle size range and time resolution of the instruments

Instrument	Size resolution	Time resolution
CPC	One channel >7nm	1s (transients)
SMPS	64 channels per decade 7 - 300nm for LD and 10 - 400nm for HD	90s for LD 60s for HD (steady-states)
ELPI	7 impactor stages (i.e. excluding the filter stage) 30 - 1000nm	1s (transients)
ASMO	One channel, 7 - 1000nm	1s (transients)
DGI	5 stages, 1nm - 10µm	Integrated over a test
DDMPS	2 - 500nm	60s (steady-states)
TrDMPS	10 - 640nm	0.2s (transients)

## 5. DATA HANDLING AND STATISTICAL ANALYSIS

### 5.1. DATA HANDLING

A number of different techniques were used to measure the number, surface area and mass of particles over transient and steady-state conditions as detailed in **Table 7**. Each technique measured particulate emissions over a different size range (see **Table 8**). Some of these techniques (DGI, ELPI, SMPS, TrDMPS, DDMPS) yielded distributional data showing the numbers or mass of particles of different sizes, while others (regulated PM, CPC, ASMO) simply measured total mass or surface area. In this report, the total number, surface area or mass of particles in a specific size range or ranges is presented for each technique. Full distributional data from the SMPS are also presented (see **Appendix 3** for an explanation of the units  $dN/d\log_{10}d_p$ ).

### 5.2. DATA VALIDATION

The first stage in the validation process was to examine the regulated emission results for outliers and trends as detailed in [1]. Unusual regulated emissions in a particular test would lead to concerns that the particulates data might also be suspect. The next step was to view the actual particulates data and determine to what extent any anomalies in the regulated emissions data had been further transmitted to the particulates data.

The total number/surface-area/mass measurements by each technique were also examined for outliers and trends by fitting analysis of (co)variance models and inspecting studentized residuals (residuals divided by their standard errors). See **Appendix 3** for details.

A small number of data points were missing due to various test failures. Also some ETC tests in the Euro-5 engine were delayed until the end of the test programme as a result of the limited availability of the TrDMPS.

One test on fuel D8 in car A was rejected in its entirety due to a suspected emissions leak. The ELPI, CPC and ASMO results from the NEDC cycle in one of the tests on fuel D4 in the same car were also rejected as outliers as these were several orders of magnitude lower than the other two tests on that fuel.

The complete SMPS and DDMPS results were rejected for the first test on fuel D5 in the trap-equipped Euro-4 engine as the numbers of nucleation-mode particles measured in this particular test were abnormally low. The SMPS was operating near its limit of detection. No other heavy-duty data were rejected.

The first tests on fuel G1 in both gasoline cars C and D were also rejected en bloc due to abnormally high regulated and particulate emission levels. This was believed to be due to the vehicle not being fully conditioned to the daily test cycles.

A small number of DGI results were rejected on the basis of statistical outlier tests. These measurements were abnormally high relative to those observed in other tests on the same vehicle and would have seriously distorted the fuel averages. No explanation has been found for these anomalies.

No trend corrections were deemed necessary with the randomized blocks experimental design minimising the risk of bias due to drift in vehicle performance or other systematic effects (see **Section 4.1**).

Some emissions were below the limits of detection and were treated as zero in the data analysis.

### 5.3. STATISTICAL ANALYSIS

The test programme was constructed using the principles of statistical experimental design as described in **Section 4.1**.

Each number, surface-area and mass measurement (see **Table 7**) was examined on a vehicle-by-vehicle and cycle-by-cycle basis. Only the overall ESC and ETC (heavy-duty engines) and the NEDC and Artemis motorway cycle data (light-duty vehicles) were examined in detail for all measurements. Some steady-state measurements of interest by certain techniques were also looked at.

The variability in most emission measurement processes increases as the actual level of emissions increases. Therefore variations between repeat tests are usually assumed to follow the lognormal distribution [19,21-27]. Nevertheless in EPEFE [19] and subsequent CONCAWE programmes [3,17,24-27], simple arithmetic means were used to summarise the regulated gaseous and particulate mass emissions for the various vehicle × fuel combinations. Arithmetic means were chosen as geometric (i.e. logarithmic) means tend to underestimate total emissions to the atmosphere.

Average regulated particulate mass emissions are presented as arithmetic means in the graphs in **Section 6**. Arithmetic means are also used to summarize mass emissions measured by the DGI. There are large numbers of zeros in the DGI data corresponding to measurements below the limit of detection and these are more readily included in arithmetic mean calculations. Mass emissions are plotted on the original g/km or g/kWh scale and standard errors and error bars are computed using weighted analysis of variance techniques (see **Appendix 3**).

Particle number and surface-area measurements by the SMPS, DDMPs, TrDMPs, ELPI, CPC and ASMO are much more variable than particle mass measurements with test results typically varying by one or more orders of magnitude. Geometric means are used to average number and surface-area measurements in order to reduce the influence of isolated high results, which can inflate arithmetic means unduly. Logarithmic axes are used to plot number and surface-area measurements.

In the bar charts presented in **Section 6**, the error bars show the

mean value  $\pm 1.4 \times$  standard error of mean

The factor 1.4 was chosen for consistency with both the EPEFE [19] and recent CONCAWE reports [24-26]. Emissions from two fuels will not be significantly different from one another at  $P < 5\%$ <sup>2</sup> unless there is a clear gap between their error bars. See **Appendix 3** for further discussion.

---

<sup>2</sup>  $P < 5\%$  = the probability that such an event could be observed by chance when no real effect exists is less than 5%. In other words, we are 95% confident that the effect is real.

In the detailed SMPS size distribution data, the numbers of particles measured in certain bins were below the limit of detection in some tests and so are recorded as zero. Therefore small offsets near the limit of detection of  $10^7 \text{ dN/dlog}_{10}d_p \text{ km}^{-1}$  (light-duty) and  $10^8 \text{ dN/dlog}_{10}d_p \text{ kWh}^{-1}$  (heavy-duty) were added to each data point before calculating geometric means (see **Appendix 3** for details). These offsets have very little effect on the geometric mean distribution when particle numbers are at higher levels.

## 6. TEST RESULTS AND DISCUSSION - GENERAL

The main focus of this report is on the results from the legislative test cycles. Although a vast body of data was generated, results from specific additional test modes are only described in this report where they help explain the primary test cycle data or impact the conclusions. The detailed results, summary sheets and raw data files, are archived in CONCAWE.

### 6.1. HEAVY-DUTY ENGINES

#### 6.1.1. Regulated particulate mass (PM) emissions

Regulated particulate mass data over the standard EU cycles, ESC and ETC, are shown in **Figure 2** and **Figure 3**.

**Figure 2** PM emissions - ESC

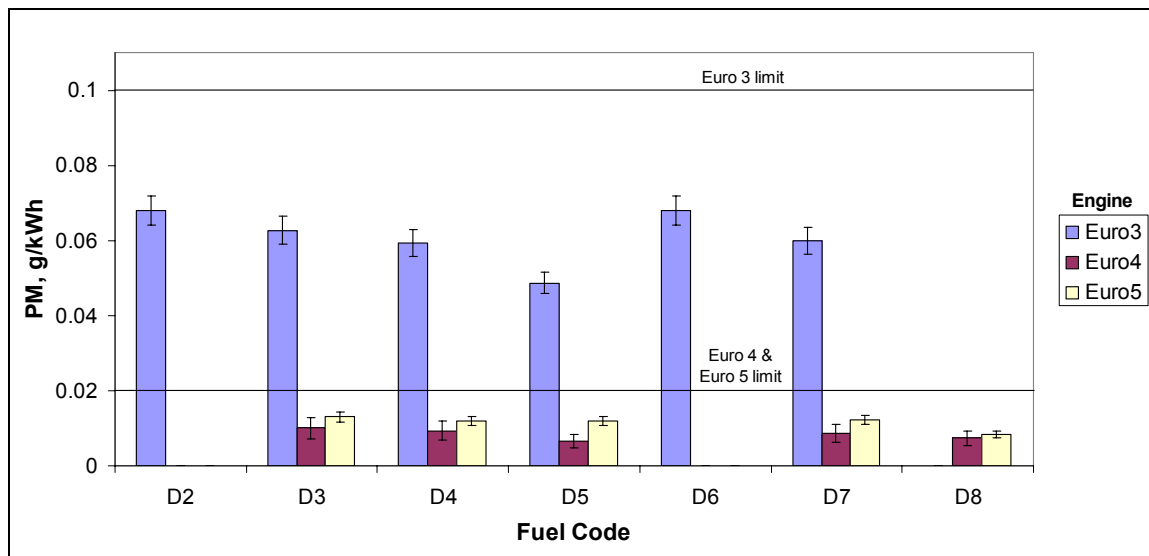

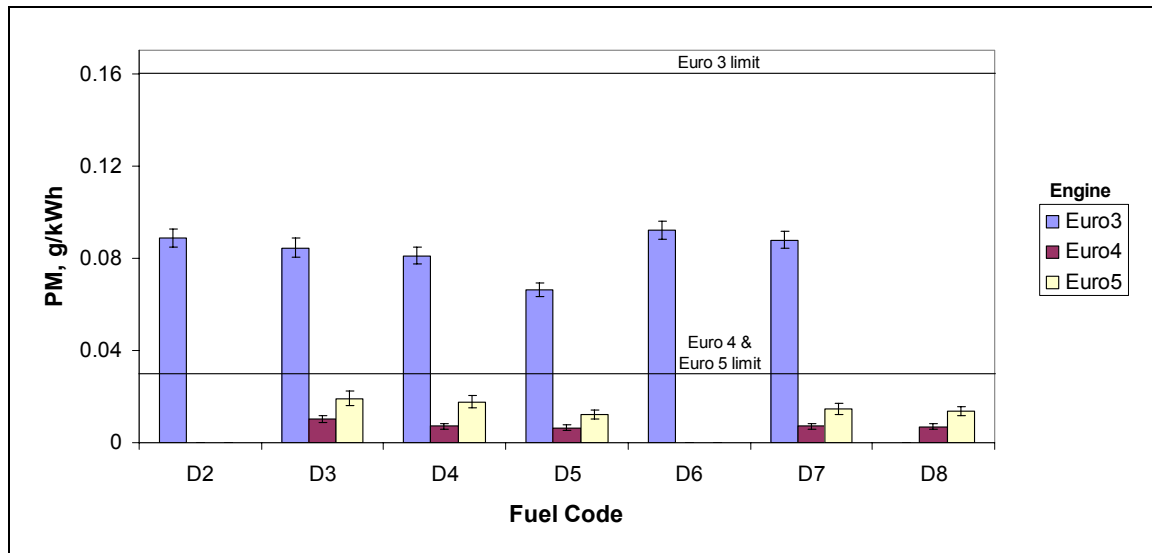
**Figure 3** PM emissions - ETC

- All 3 engines performed well within their respective emissions limits in the ESC and ETC tests.
- The ESC and ETC test results showed similar patterns, which were generally consistent with the steady-state tests (not shown here).
- Advanced engine/after-treatment technologies delivered very low PM emissions.
- Euro-4 and Euro-5 engines produced significantly less PM than Euro-3 in-line with the expected progress in emissions control.
- The Euro-4 engine equipped with a DPF produced the least PM.
- In the Euro-3 engine, reducing fuel sulphur content gave small reductions in PM emissions.
- The two 300ppm sulphur fuels (D2 and D6) gave similar PM emissions.
- Fuel D5 (Swedish Class 1 diesel) and D8 (Fischer-Tropsch) showed lower PM emissions than D4, though the absolute effect was much smaller in the advanced engines.
- The use of 5% RME (D7 blended from D4) did not reduce PM emissions.

### 6.1.2. Total number of carbonaceous particles

Changes in regulated particulate mass might be expected to be reflected in changes in accumulation mode (carbonaceous) particles. The ELPI (used with a thermodenuder on the “dry” branch), provides a direct measure of these carbonaceous particles, so these data are considered next. Again results are shown for the ESC and ETC tests. Due to the large spread of data, particle number charts are shown on a logarithmic scale and geometric means are used for averaging the repeat tests. ELPI data are shown for the ESC in **Figure 4** and the ETC in **Figure 5**.

**Figure 4** Total particle count, ELPI stages 1-7 (30-1000nm) + thermodenuder, ESC

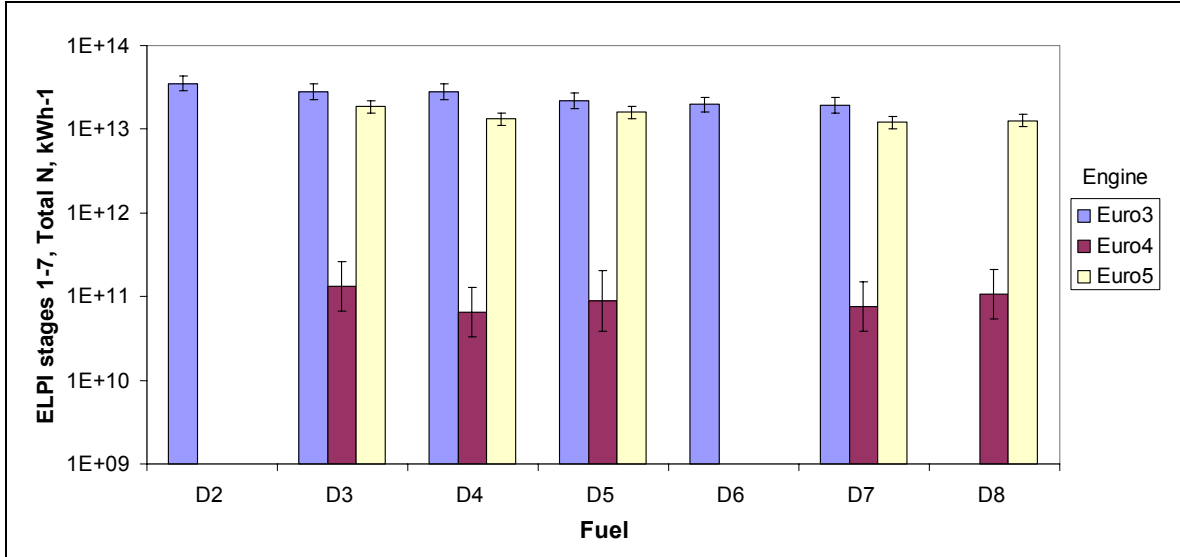

**Figure 5** Total count ELPI stages 1-7 (30-1000nm) + thermodenuder, ETC

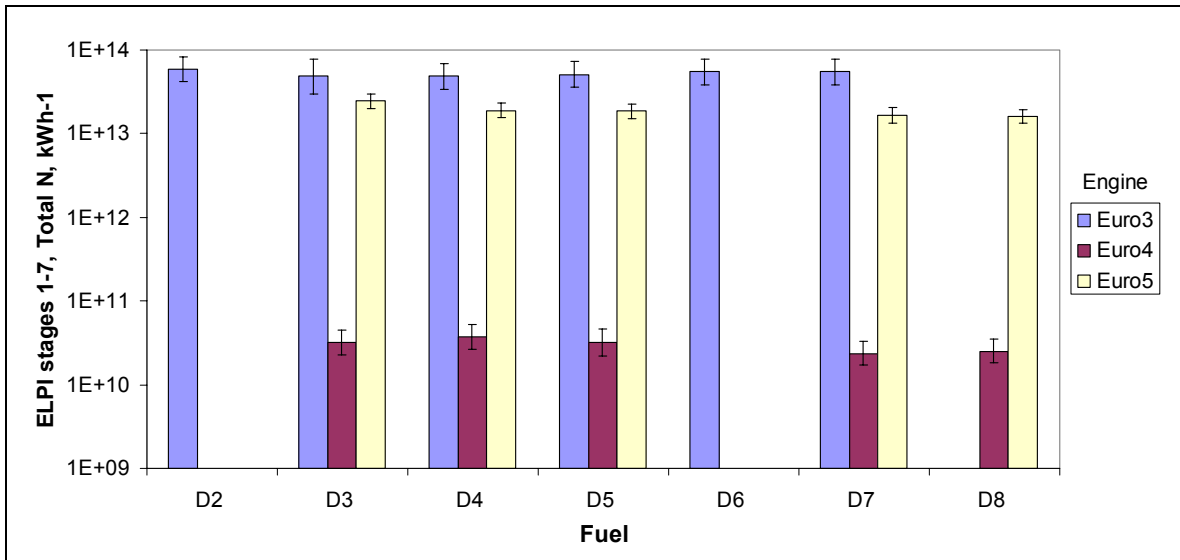

- No consistent fuel effects were seen on the number of dry carbon particles as measured by the ELPI.
- Fuel effects seen in particulate mass were not reflected in numbers of carbonaceous particles as measured by the ELPI.
- The Euro-4 engine with a CRT provided 2 to 3 orders of magnitude reduction in dry particle number versus the Euro-3 engine.



- The Euro-5 system with SCR/urea (but without a particle trap) produced up to 70% fewer dry particles than the Euro-3 engine but still considerably more than the Euro-4 engine with a CRT.
- At high load (SS3 – **Figure 6**), the Euro-5 engine emitted the most particles.

**Figure 6** Total count ELPI stages 1-7 (30-1000nm) + thermodenuder, SS3

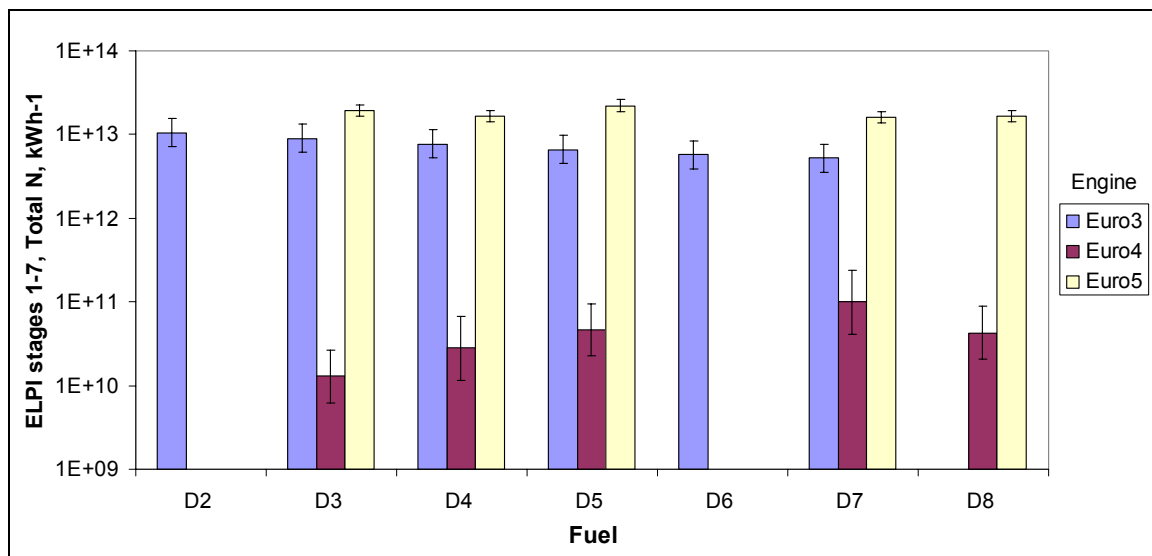

### 6.1.3. Total particle count

Total particle number count, including the “volatile” particles, is considered next. Different measurement techniques were used depending on engine operation: SMPS and DDMPS for steady-state and CPC and TrDMPS for transient operation. For steady-state tests, size distribution data were generated at each mode of the test cycle. Integration under each curve allows the calculation of the number of particles generated (over that size range) for each mode and, following application of the appropriate weighting factors, these can be combined to produce a total particle count for the complete cycle. For all the measurements reported in this section, samples were taken from the “wet” branch or in the case of DDMPS and TrDMPS, from raw exhaust using their own dilution systems. Number counts may be expected to differ slightly between instruments due to different size ranges measured.

**6.1.3.1. Steady-state data**

The total particle count data are shown below for the SMPS (**Figure 7**).

**Figure 7** ESC Total particle count by SMPS

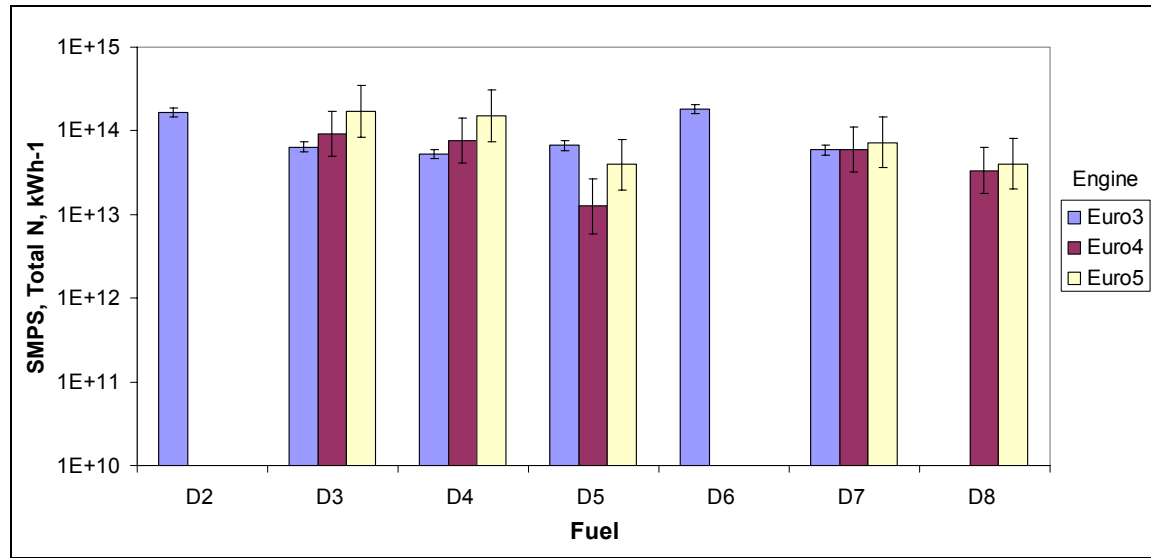

- In the Euro-3 engine, the two 300ppm sulphur fuels (D2 and D6) gave the highest emissions: reducing fuel sulphur content gave lower particle number emissions.
- There was little difference between the other fuels in the Euro-3 engine, but in the Euro-4 and Euro-5 engines, fuels D5 and D8 gave the lowest emissions.
- Trends in mass emissions between the three engines (**Figure 2**) were not reflected in trends in total particle number emissions. In particular, total particle numbers from the Euro-4 engine with CRT were generally no lower than for the Euro-3 engine on the ESC cycle.

This is further explained by examining the split between particles less than and greater than 30nm, as shown for both SMPS and DDMPS in **Figure 8** and **Figure 9**.

**Figure 8** ESC total particle count by SMPS: particles <30nm and >30nm

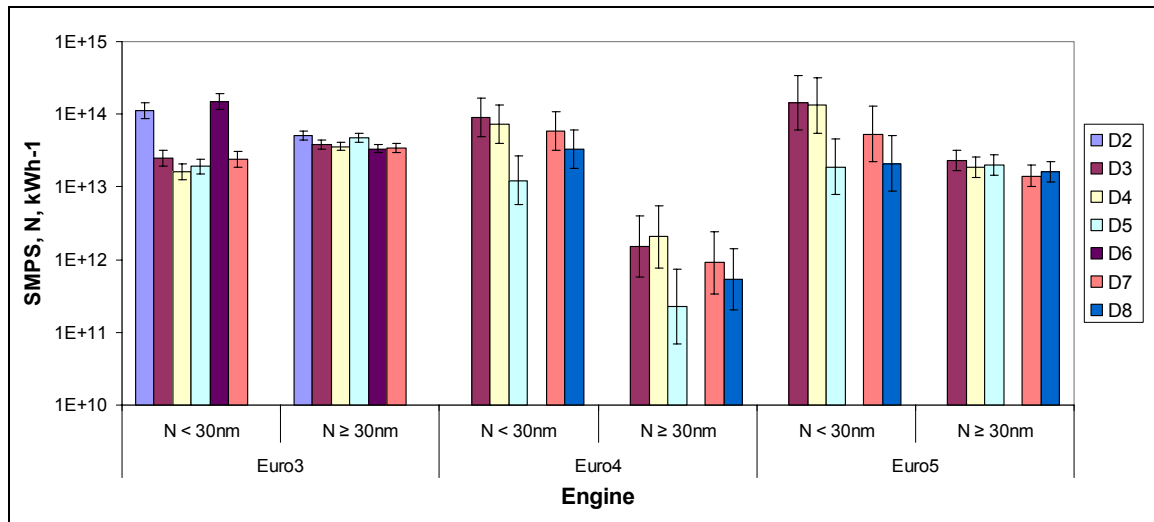

**Figure 9** ESC total particle count by DDMPs: particles <30nm and >30nm

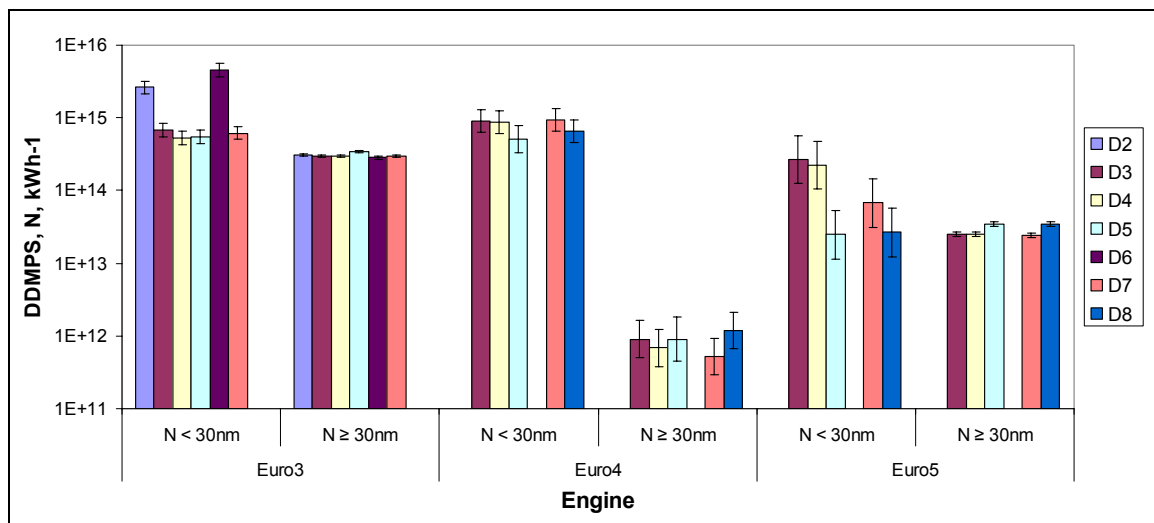

- Fuel effects on particles <30nm were greater than those on particles >30nm, indicating that the nucleation mode is responsible for most of the fuel effects. Fuel sulphur was the dominant effect consistent with the formation of sulphate particles.
- In the Euro-3 engine, the high sulphur fuels, D2 and D6, gave the highest number of particles below 30nm, showing the benefit of sulphur reduction for nucleation mode particles.
- The Euro-4 engine, equipped with the CRT produced the lowest number of accumulation mode particles. However, the use of after-treatment did not directly reduce the number of particles below 30nm (nucleation mode).

- Overall the combination of advanced engines/after-treatment and lower sulphur fuels provided clear benefits over the Euro-3 engines on 300ppm S fuels.
- Engine technology and fuel trends were similar for SMPS and DDMPS measurements, though there were some differences in absolute particle numbers, highlighting the sensitivity to small changes in the measurement systems.

**SMPS Distributions**

A SMPS distribution was measured for each of the 13 modes of the ESC over the selected size range (actual range monitored 10-400nm). These distributions were combined, taking the averages from repeat tests and applying the appropriate weighting factors for each mode, to produce a size distribution representative of the complete cycle in number/kWh [20]. **Figures 10-12** show these calculated distributions for the Euro-3, Euro-4 and the Euro-5 engines.

The particulate emissions from the trap-equipped Euro-4 engine were extremely low with the SMPS operating near its limit of detection over the majority of the size range. This has resulted in some missing data which make the averaging of the distributions difficult. Hence **Figure 11** shows all fuels and their repeats.

**Figure 10** ESC: SMPS distribution for each fuel in the Euro-3 engine

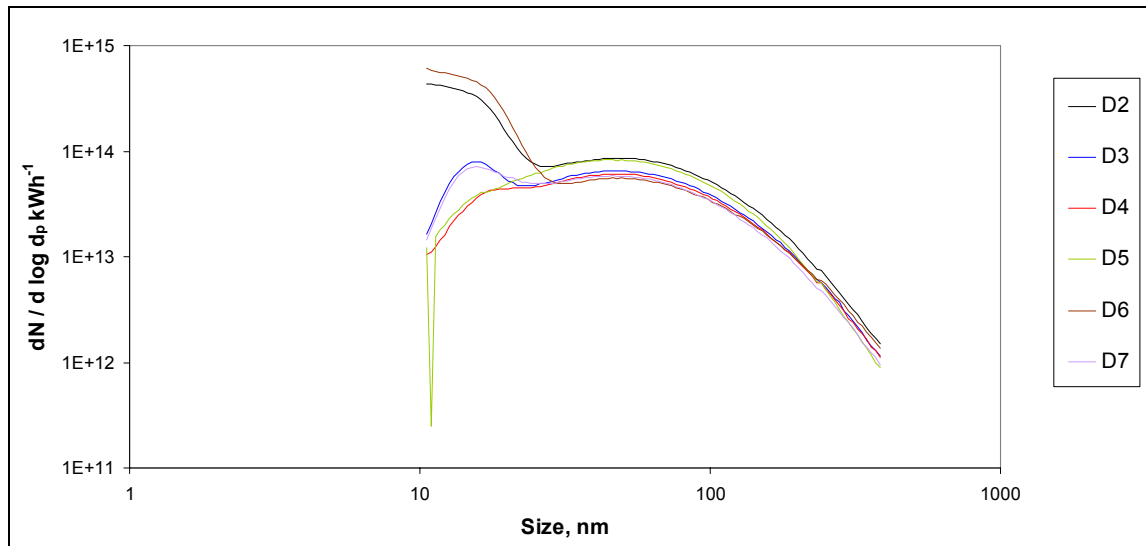

**Figure 11** ESC: SMPS distribution for each fuel in the Euro-4 engine

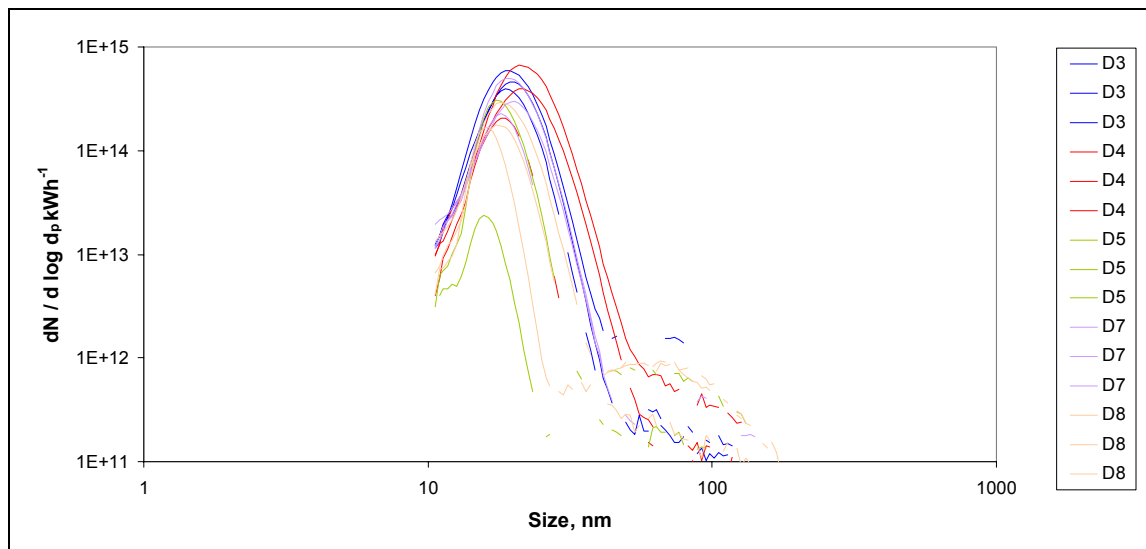

**Figure 12** ESC: SMPS distribution for each fuel in the Euro-5 engine

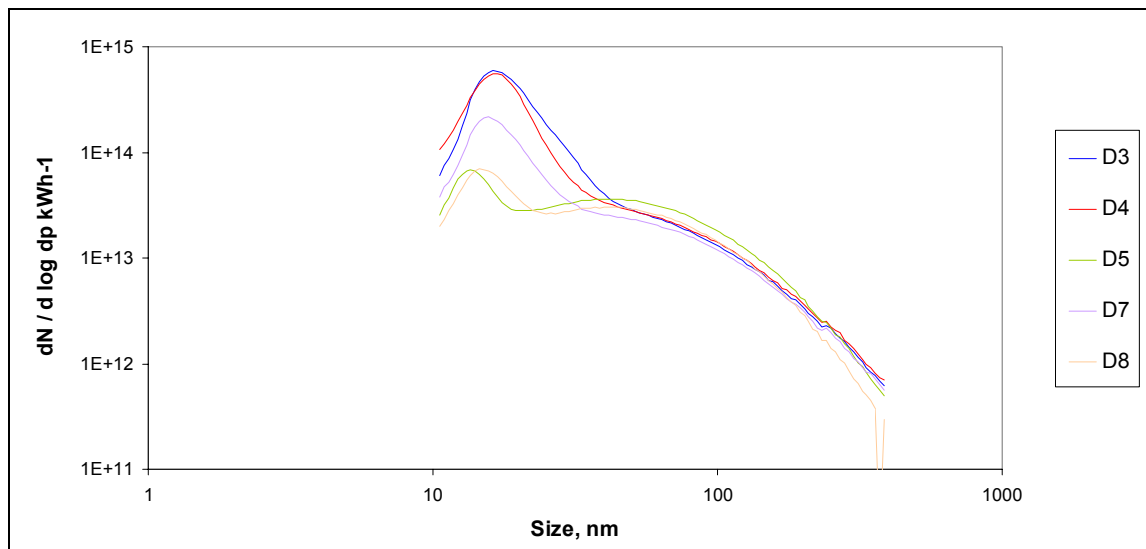

These distribution data confirm the conclusions made from **Figures 8** and **9**. However, there are some additional points that can be made.

- The extent of the production of the nucleation mode particles and the shape of their distribution differs between the three engines.
- Fuel effects are more pronounced in the Euro-3 engine and are dominated by fuel sulphur content.

- The accumulation mode was dramatically reduced by the Euro-4 engine, equipped with a particulate trap. The accumulation mode was still present in the Euro-5 engine with SCR de-NOx, but at a lower level than in the Euro-3 engine.
- The Euro-4 & 5 engines produced nucleation mode particles on all the fuels.

**6.1.3.2. Transient data**

The total count data for the ETC are shown in **Figure 13** for the CPC and in **Figure 14** for the TrDMPS data. The split between particles less than/greater than 30nm for the TrDMPS is shown in **Figure 15**. Unlike the steady-state data, only the TrDMPS data can be split into size fractions – the CPC gives a non-size-discriminated count. However, the TrDMPS data were generated in a single ‘block’ of 2 back-to-back repeat tests so may be considered less robust. All measurements in this section were taken from the ‘wet’ branch or in the case of TrDMPS, from raw exhaust using its own dilution system, so include both nucleation and accumulation mode particles.

**Figure 13** ETC total particle count by CPC

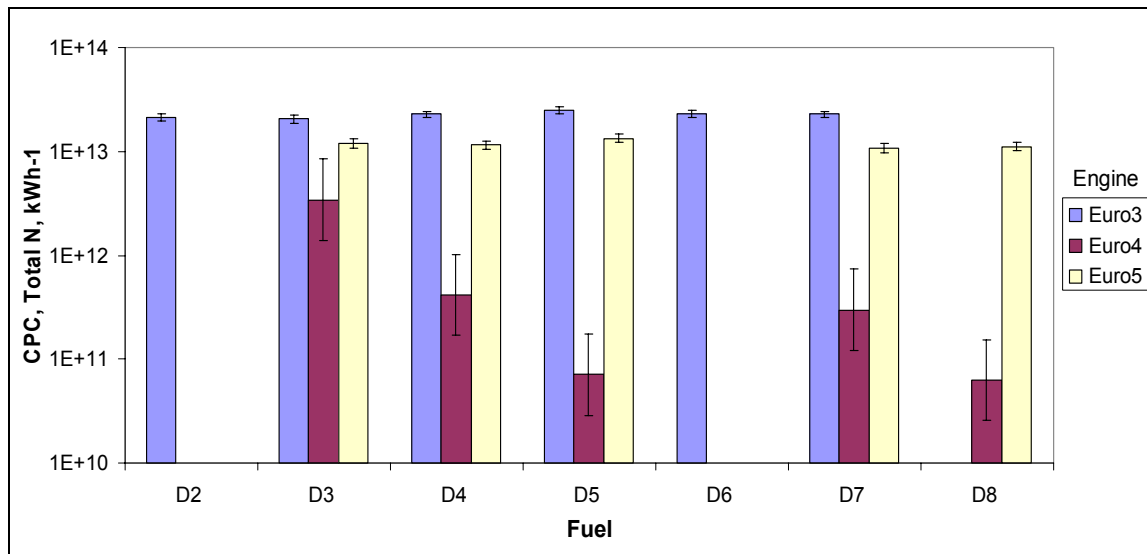

- The Euro-3 engine produced most particles, followed by the Euro-5 engine, with the lowest results on the Euro-4 engine with DPF. However, the CPC reached saturation in the Euro-3 and some of the Euro-5 engine tests, making it difficult to draw conclusions on fuel effects.
- The Euro-4 engine produced the lowest emissions, especially in combination with fuels D5 (Swedish Class I) and D8 (FT).

**Figure 14** ETC total particle count by TrDMPS

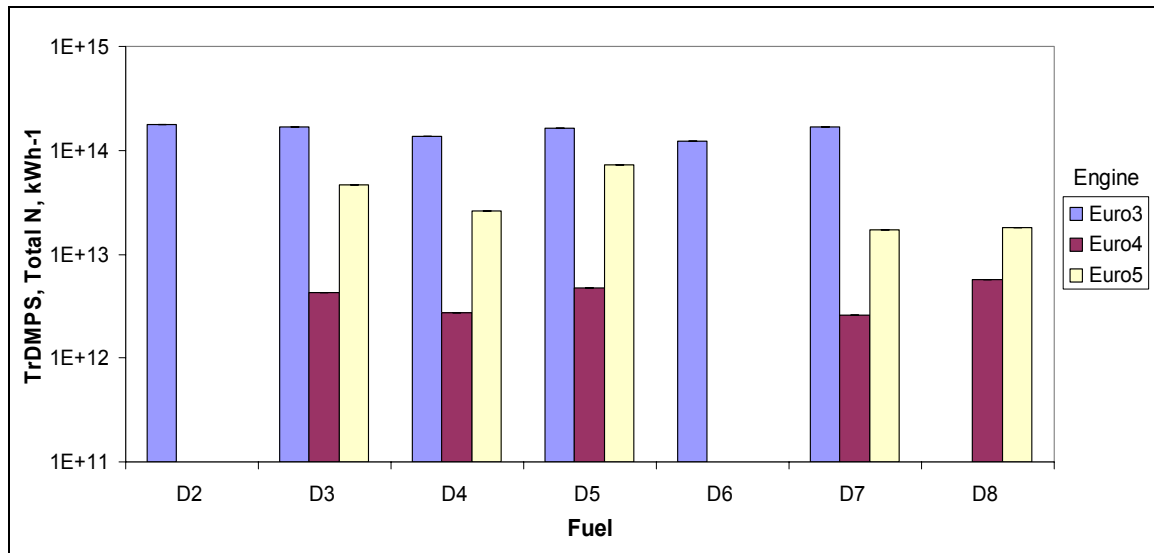

- The overall pattern of results from the TrDMPS was similar to the CPC, though in this case fuels D5 and D8 showed higher particulate number emissions in the Euro-4 trap-equipped engine than the other fuels. It is not possible to quantify the statistical significance of this effect as the repeat tests were carried out back-to-back.

**Figure 15** ETC total particle count by TrDMPS: particles <30nm and >30nm

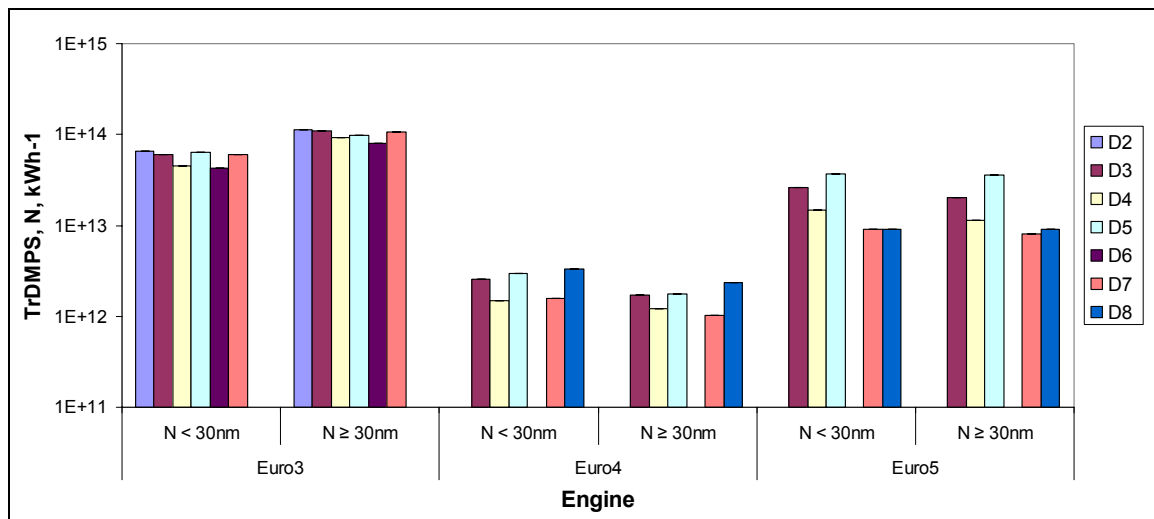

- Unlike in the ESC tests, the Euro-4 engine with CRT reduced the numbers of particles both above and below 30nm. The lower number of smaller particles probably reflects the lower operating temperature of the ETC.
- Even the 300ppm S fuels (D2 and D6 which were only tested in the Euro-3 engine) did not stand out under the ETC test conditions.

**6.1.4. ASMO – total surface area**

The total surface areas measured by the ASMO are shown in **Figure 16** and **17** for the ESC and ETC cycles. The ASMO was not available for the tests on the Euro-3 engine.

**Figure 16** ASMO total surface area - ESC

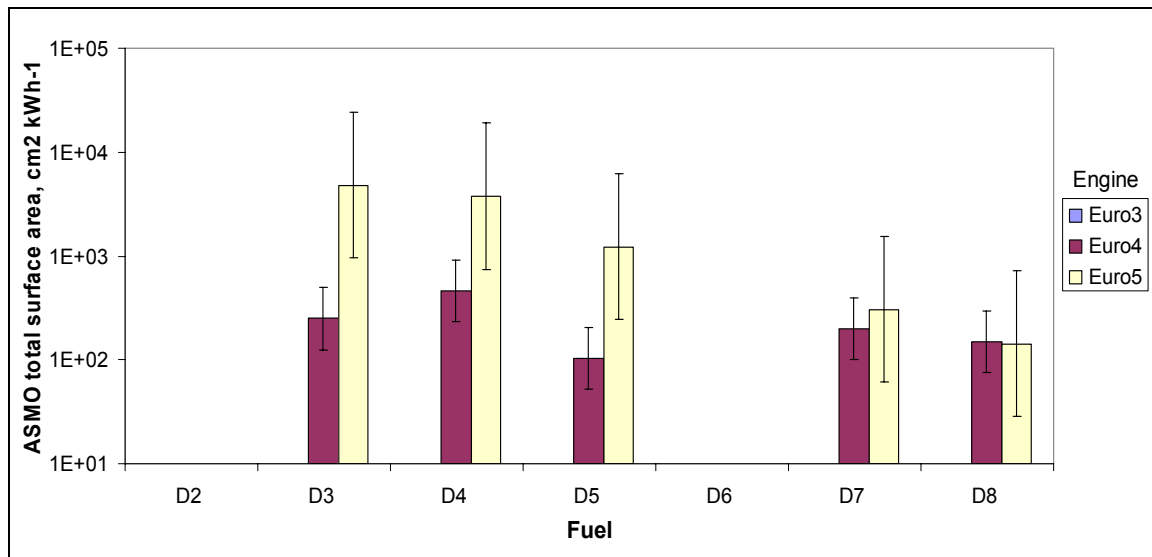

**Figure 17** ASMO total surface area - ETC

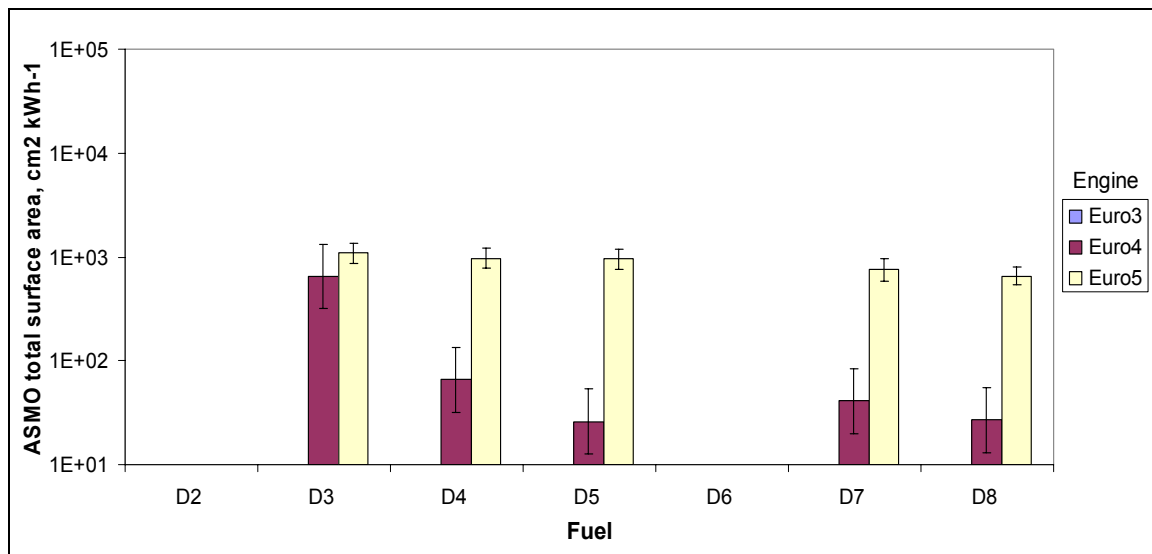

- The Euro-5 engine generally produced a higher total surface area than the Euro-4 engine, reflecting the higher number of particles measured by the ELPI and SMPS.



- The variability of the ASMO measurements was generally higher than the other measurement techniques.
- The surface areas measured are in broad alignment with the CPC totals (Figure 13).

## 6.2. LIGHT-DUTY DIESEL VEHICLES

### 6.2.1. Particulate Mass emissions

#### 6.2.1.1. Filter Paper

Although both cars were certified to Euro-3 emissions limits, car A is approaching Euro-4 limits and car B (with DPF) performed far below the Euro-4 limit for regulated PM. Both sets of emissions limits are shown on Figure 18 which shows the emissions over the NEDC, whilst Figure 19 gives the emissions over the Artemis Motorway cycle. This cycle from the Artemis testing was chosen as being the most different to the NEDC with respect to speed (and therefore temperature) and thus showing the widest possible effects of driving conditions.

Figure 18 Regulated PM emissions - NEDC

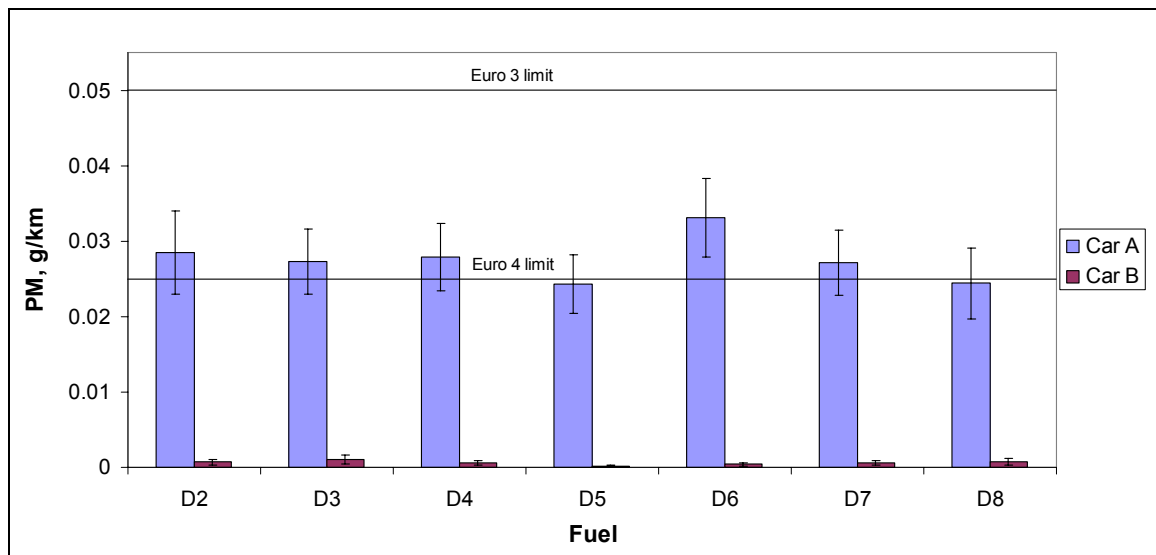

- Car A, although certified to Euro-3, produced PM emissions close to the Euro-4 limits. In this car, fuel D6 gave the highest PM emissions, Swedish Class 1 (D5) and FT diesel (D8) gave the lowest PM emissions. The addition of 5% RME to fuel D4 (cf. D7 vs. D4) did not significantly affect PM emissions.
- The more striking effect was that of the diesel particulate filter (DPF). Car B produced extremely low PM emissions, below 10% of the Euro-4 limit on all fuels, due to the DPF. In this car, the differences between fuels on PM emissions over the NEDC were not significant.

- The changes in fuel sulphur between fuels D2-D4 did not affect the regulated particulate mass over the NEDC.
- D5 and D8 produced the lowest mass emissions in conventional vehicle technology, whereas in the trap-equipped vehicle, little difference between the fuels could be seen.
- The trap-equipped vehicle produced near zero particulate mass emissions on all fuels.

**Figure 19** PM emissions - Artemis motorway cycle

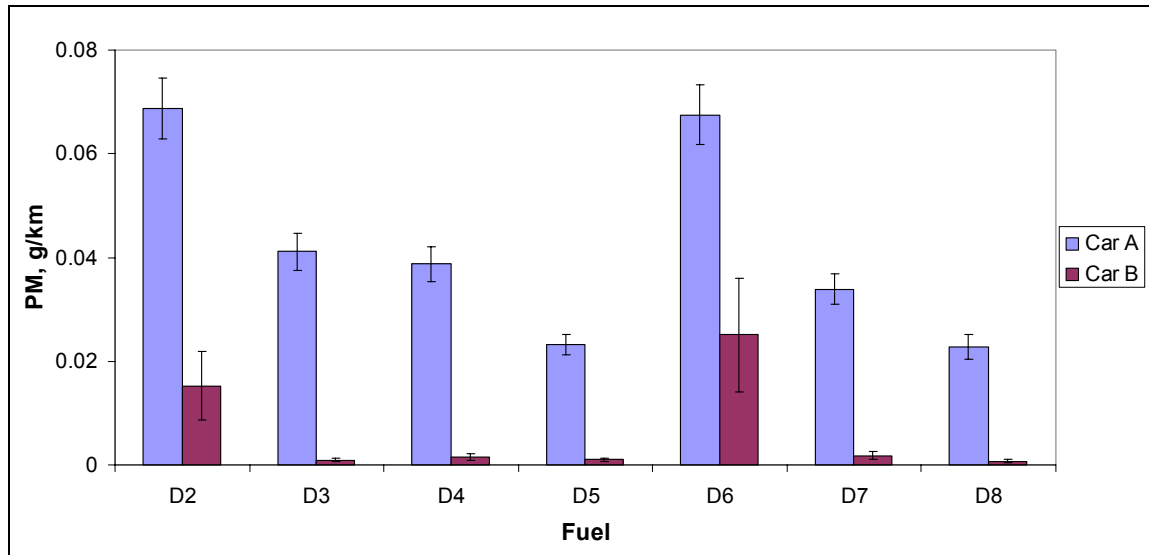

- Although the changes in fuel sulphur between D2-D4 did not affect the regulated particulate mass over the NEDC, effects could be clearly seen on the Artemis motorway cycle in both vehicles.
- D2 and D6 (300ppm sulphur fuels) produced similar emissions. These were substantially higher (and similar) over the higher temperature operating conditions of the Artemis motorway cycle, reflecting the increased catalyst activity (from both vehicles) and resultant sulphate formation.
- Fuels D5 and D8 showed further benefits over the other fuels in car A, but not in car B, as the PM emissions with this DPF-equipped car were so low on all fuels with below nominal 50ppm sulphur content.
- The trap-equipped vehicle produced near zero particulate mass emissions on all of the fuels with 50ppm or less sulphur.

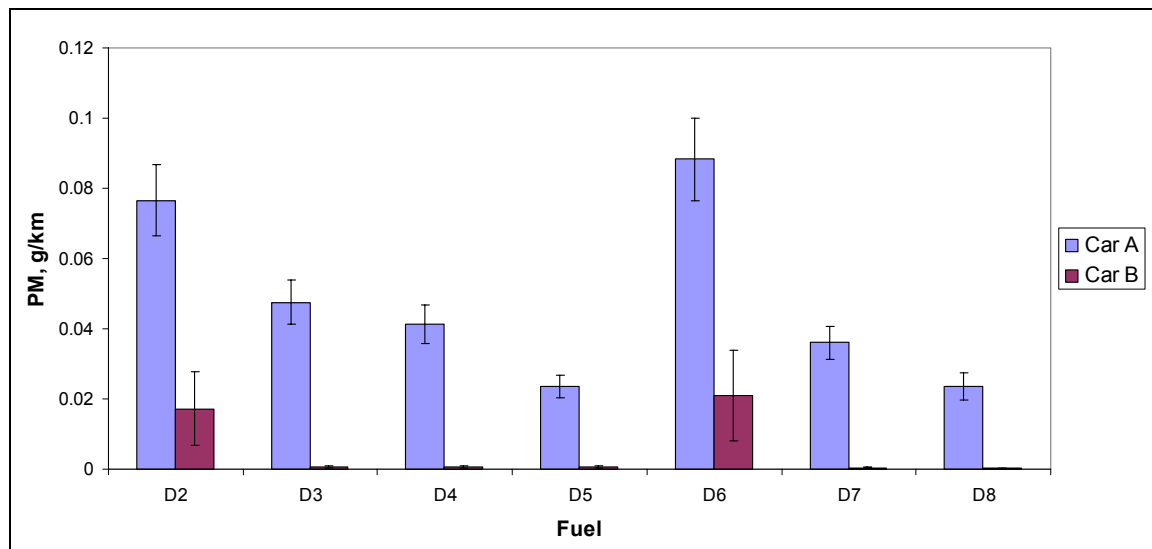
**Figure 20** PM emissions at 120 km/h

- Fuel trends were seen to be related to speed, with higher speed (temperature) conditions producing trends very similar to those seen over the Artemis cycle, whereas at lower speeds, the trends were more in line with the NEDC. This is represented in **Figure 20** for the 120km/h test condition.
- Sulphate formation was confirmed by analysing the filter deposits from the tests on fuels D2 and D6 in car B at 120 km/h steady speed and on the Artemis motorway cycle. This showed that 55% to 70% of the mass found on the filter paper was pure sulphate. Adding the bound water fully accounts for the collected particle mass. For fuels D3, D4, D5, D7, D8 with sulphur content of 50 mg/kg or below, PM emissions were close to zero.

#### 6.2.1.2. Gravimetric Impactor (DGI) data

Particulate mass was also measured using a gravimetric impactor (DGI) on the wet branch of the particulates dilution system. **Figures 21 and 22** illustrate the DGI data for all light-duty vehicles (diesel and gasoline).

**Figure 21** shows that most of the particulate mass is in the fraction below 200 nm.

**Figure 21** DGI data (arithmetic means) over NEDC

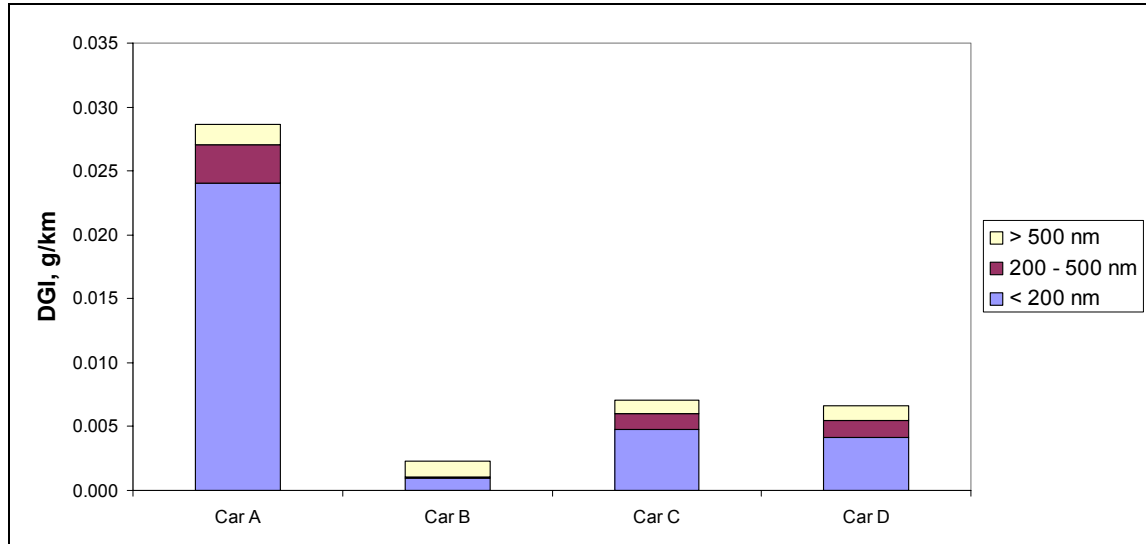

The DGI data was found to correlate directly with the standard particulate filter mass measurement (see **Figure 22**). However, the variability of the DGI data was high and a number of unexplained outlier data points had to be rejected (see **Section 5.2**). Overall, no advantage is seen for the DGI over the standard filter method.

**Figure 22** DGI versus regulated PM over NEDC

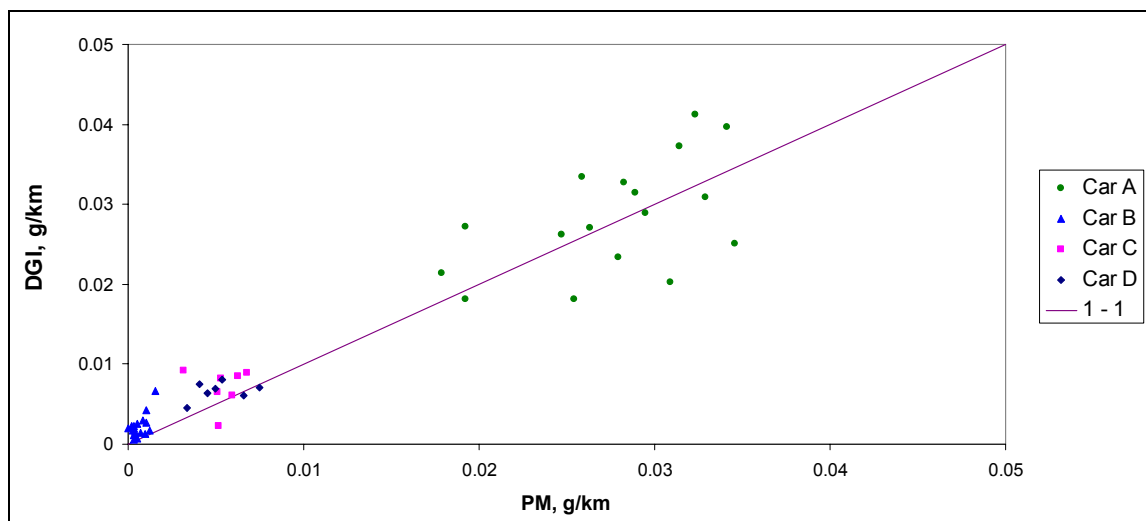

### 6.2.2. Total number of carbonaceous particles

Changes in regulated particulate mass might be expected to be reflected in changes in accumulation mode (carbonaceous) particles. The ELPI, combined with a thermodenuder, provides a direct measure of these carbon particles, so these data

are considered next. As a result of the large spread of data, particle number charts are shown on a logarithmic scale. ELPI data for the NEDC are shown in **Figure 23**.

**Figure 23** Total count ELPI stages 1-7 (30-1000nm) + thermodenuder, NEDC

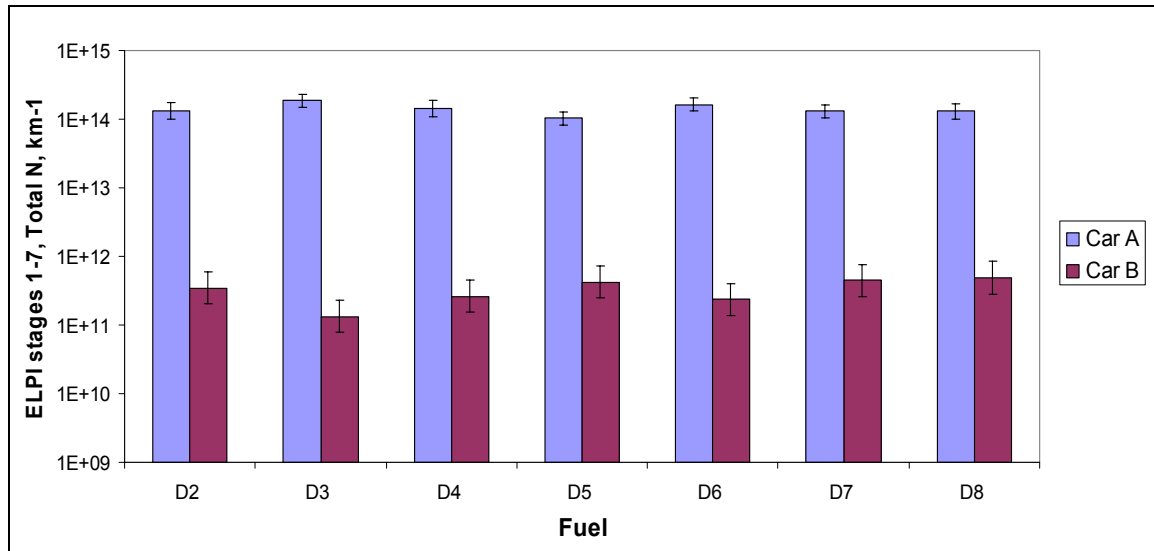

- The use of a particulate trap reduced the carbon particle number by nearly three orders of magnitude.
- There were no clear or consistent fuel effects.

The above points applied to all conditions tested, transient or steady-state. The Artemis motorway cycle is shown below as an example (**Figure 24**).

**Figure 24** Total count ELPI stages 1-7 (30-1000nm) + thermodenuder, Artemis motorway cycle

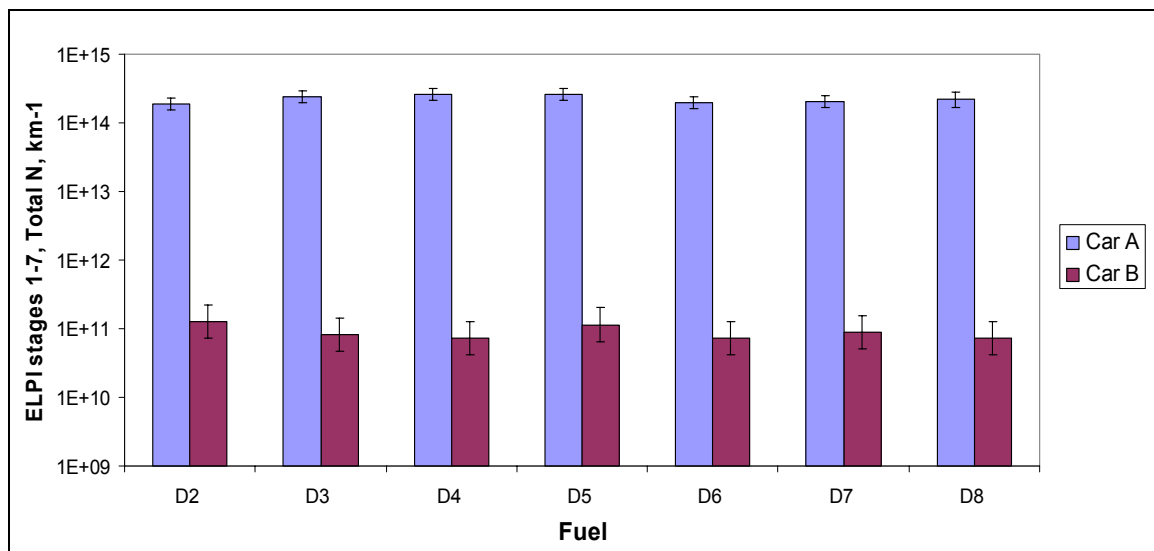

### 6.2.3. Total particle count

Total particle number count, including the “volatile” particles, is considered next. For all the measurements reported in this section, samples were taken from the “wet” branch. Different measurement techniques were used depending on engine operation: SMPS and CPC for steady-state and CPC for transient operation. Counts may be expected to differ slightly between instruments due to different size ranges measured.

#### 6.2.3.1. Transient testing

CPC data for the NEDC are shown in **Figure 25** and for the Artemis Motorway cycle in **Figure 26**.

**Figure 25** CPC total particle count - NEDC

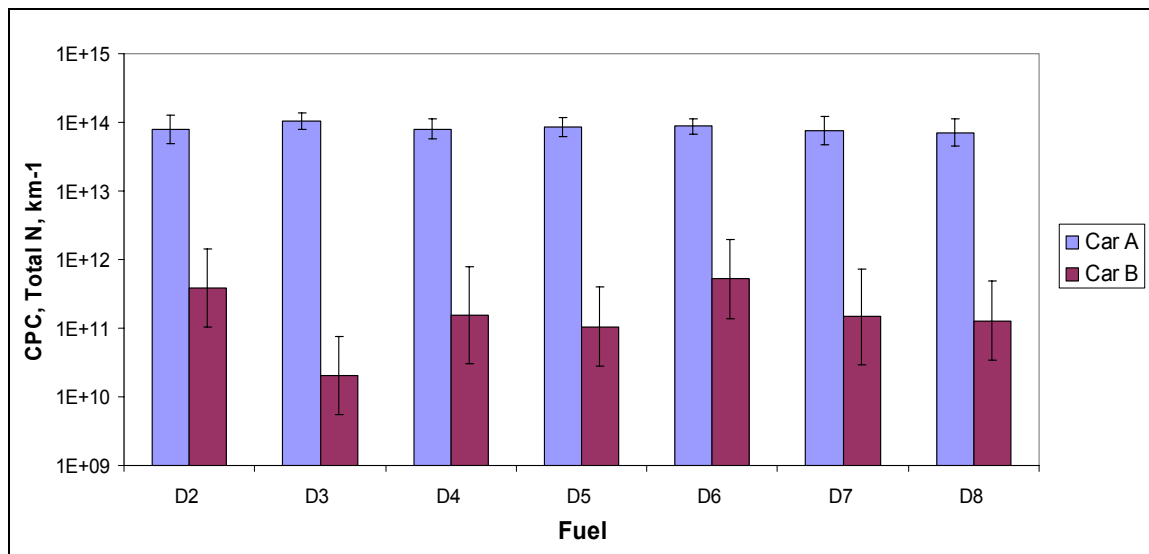

- Car A showed little fuel sensitivity over the NEDC.
- The low sulphur fuels (D3, D4, D5, D7, D8) showed lower total particle number emissions than the two 300ppm sulphur fuels (D2 and D6) in the trap-equipped vehicle.

**Figure 26** CPC total particle count - Artemis motorway cycle

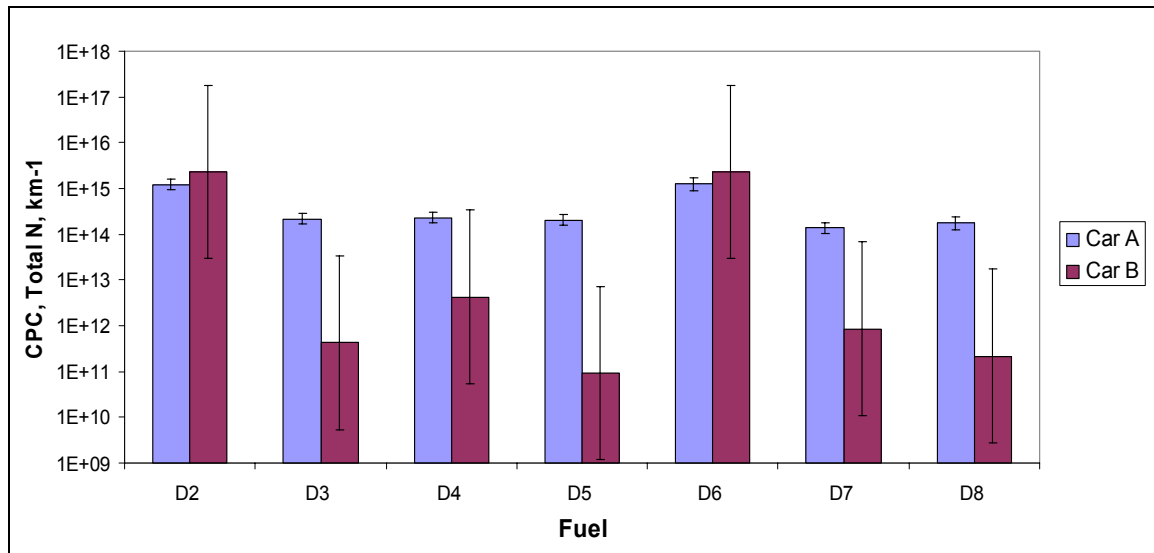

- The effect of fuel sulphur and temperature is demonstrated more clearly over the Artemis motorway cycle. Emissions with the 300ppm sulphur fuels, D2 and D6 now stand out as higher on both vehicles.
- Temperature appears to be important to the extent of response of the vehicles (and catalyst formulation/activity). Over the Artemis motorway cycle the benefits of the trap-equipped vehicle are only apparent with the low sulphur fuels. On the 300ppm sulphur fuels, the DPF-equipped vehicle emitted a similar total number of particles to the non-trap vehicle.

**6.2.3.2. Steady-state testing**

Under steady-state conditions, the use of the SMPS allowed a split of the total count into particles <30nm and >30nm. High temperature/high speed operation increased the total particle count for the 300ppm sulphur fuels, in the same way as on the transient NEDC/Artemis cycles. Comparison of the 50 km/h (**Figure 27**) and 120 km/h data (**Figure 28**) clearly shows this effect.

**Figure 27** 50km/h total particle count by SMPS: particles <30nm and >30nm

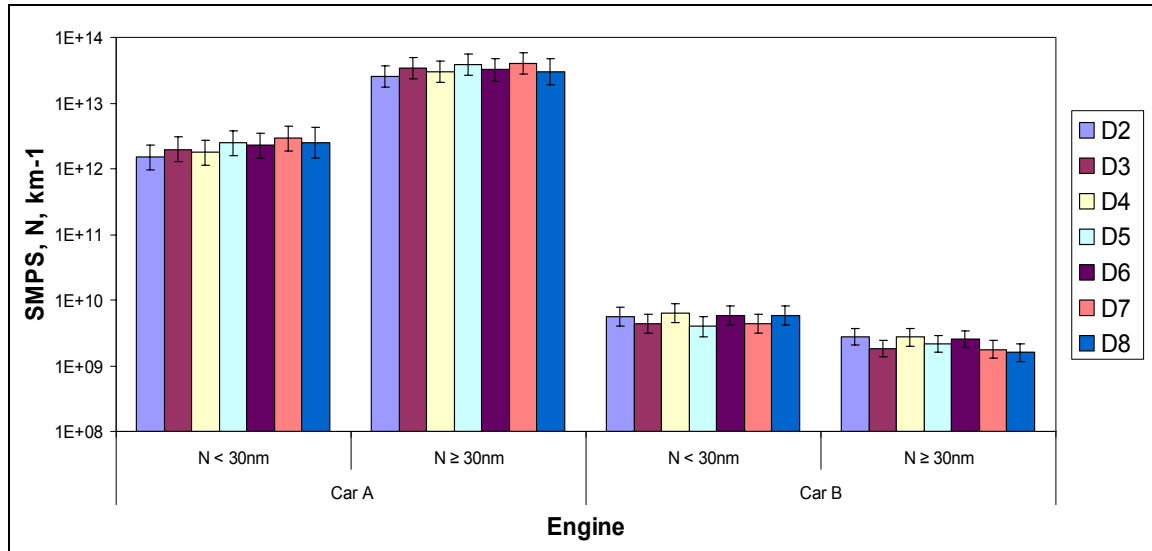

- At 50 km/h, the effect of the diesel particulate filter was obvious but there were no significant differences between fuels.

**Figure 28** 120km/h total particle count by SMPS: particles <30nm and >30nm

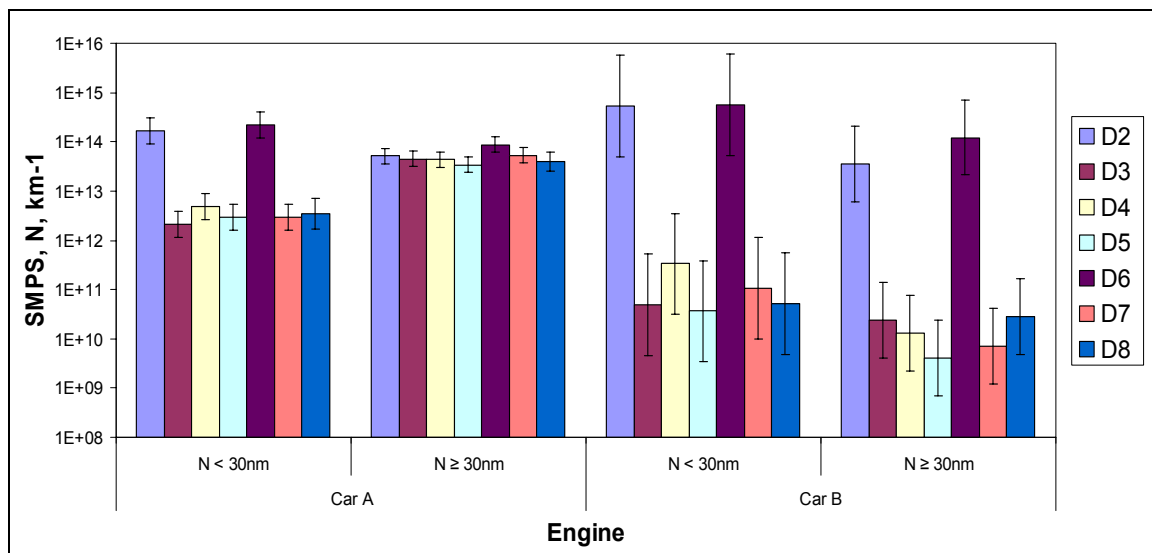

- At 120km/h, the higher sulphur fuels D2 and D6 produced significantly higher numbers of particles <30nm, especially for the trap-equipped vehicle.
- The high emissions from fuels D2 and D6 in the trap-equipped vehicle suggest that some volatile particles are falling into the >30nm size fraction.



- The effects of the DPF and fuel sulphur shown by SMPS help to explain the trends observed in mass emissions at 120 km/h and in the Artemis Motorway cycle (**Figures 19 and 20**).

**SMPS Distributions**

Under the steady-state test conditions, a full size distribution (over the range 7-300nm) was measured. The distributions measured at 50km/h for cars A and B are shown in **Figure 29**.

**Figure 29** SMPS Distributions at 50km/h

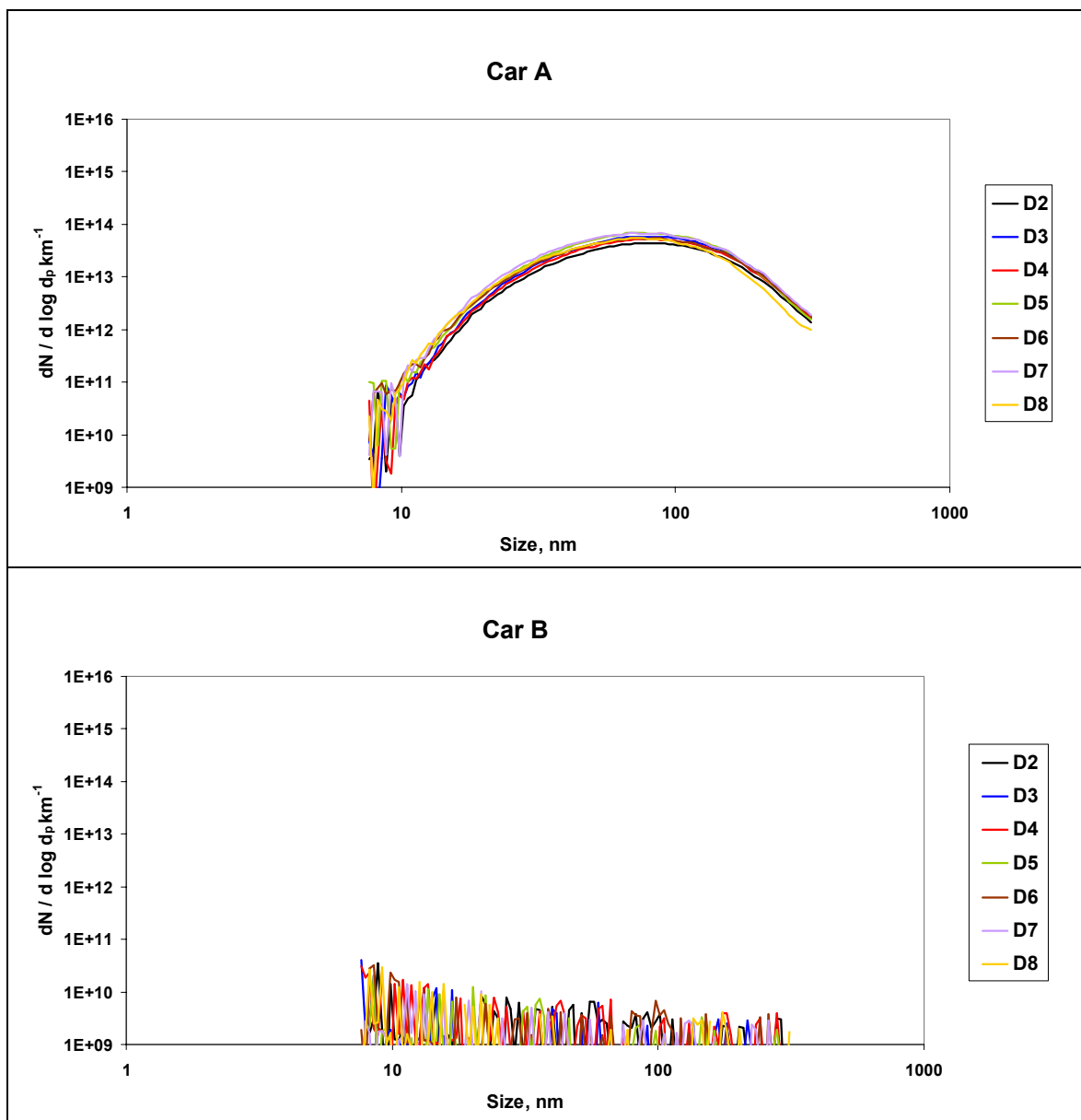

- This figure clearly demonstrates how effective the trap-equipped vehicle (car B) is at removing carbonaceous particles.

Distribution data for cars A and B when tested at 120km/h are shown in **Figure 30**.

**Figure 30** SMPS Distributions at 120km/h

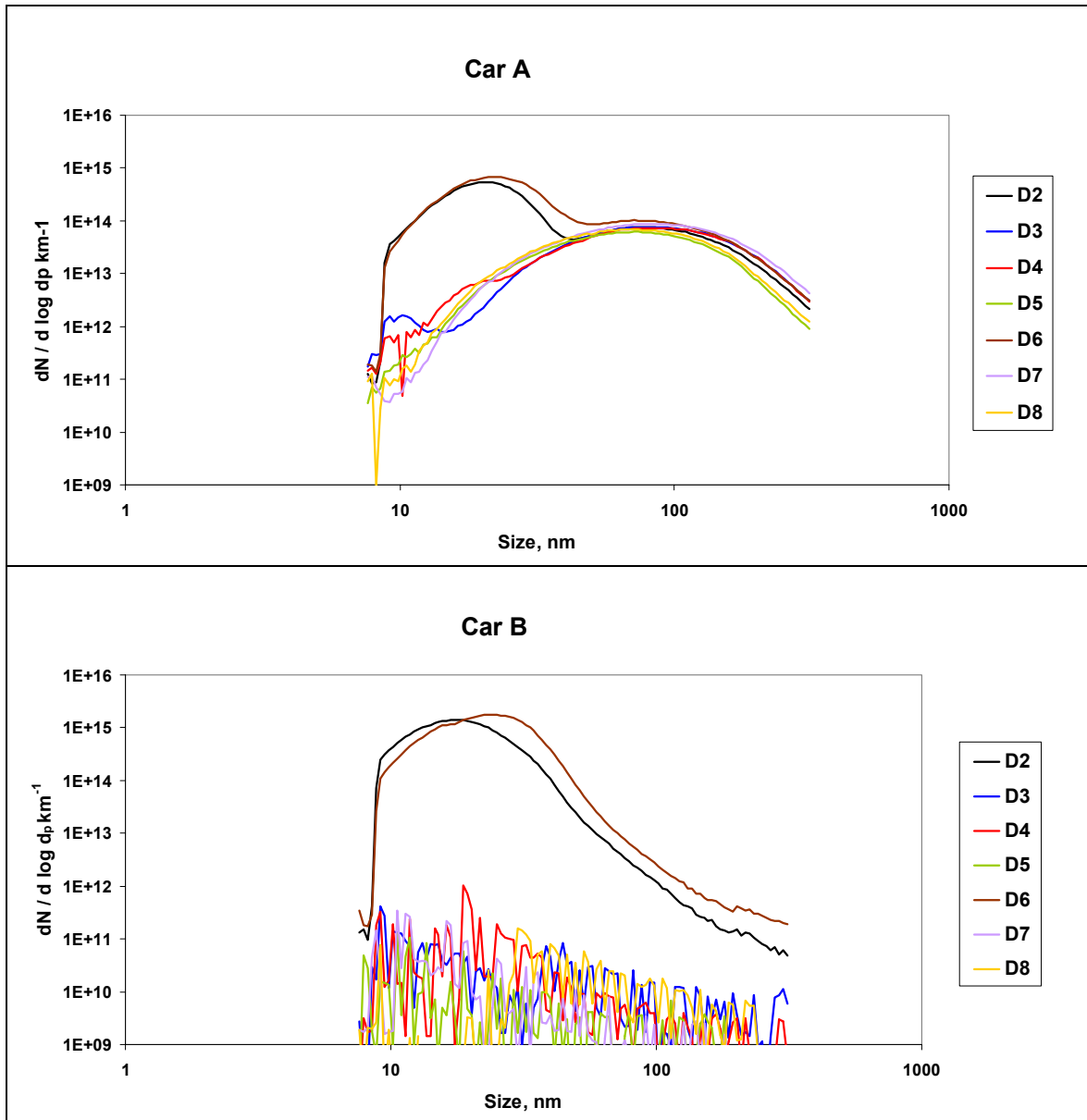

- The distribution at 120km/h for both cars is dominated by the fuel sulphur effect which increases the production of the nucleation mode particles as previously shown in **Figure 28**.
- The size distribution for the DPF-equipped car (B) confirms that with the 300ppm sulphur fuels (D2 and D6), volatile particles extend well into the >30nm size fraction.

In addition to the two steady-state conditions at road load, SMPS distributions were also measured at 50km/h using high load conditions, effectively increasing the operating temperature. The distributions measured from both cars at this condition are shown in **Figure 31**.

**Figure 31** SMPS Distributions at 50km/h - high load

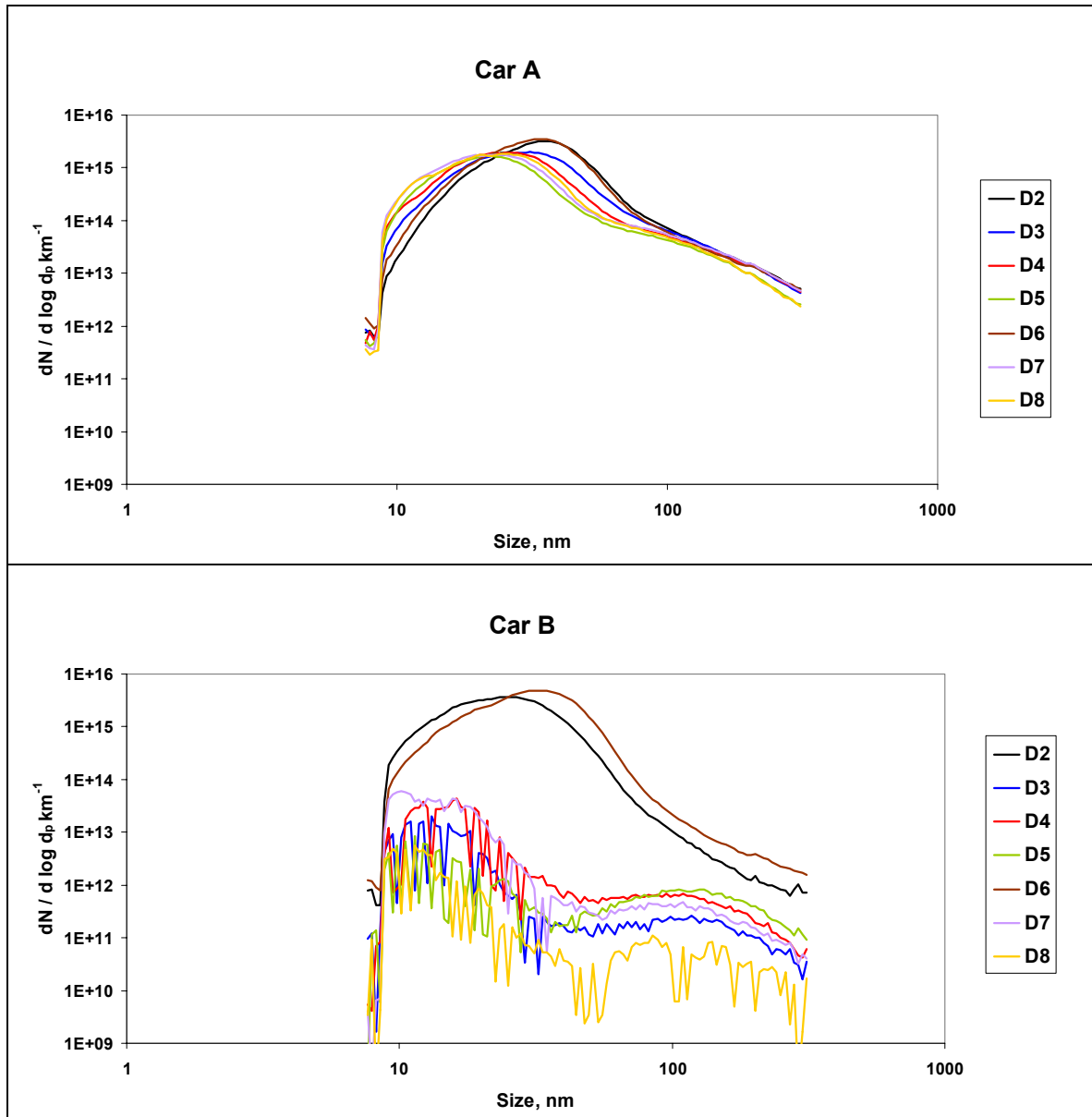

- For car A, the distribution seen as a result of the increased temperature due to high load is different to that seen at the higher temperatures related to high speed. The fuel sulphur effect is no longer dominant, with all fuels generating a similar distribution and suggests a different mechanism of particle production [28].

- For car B, the fuel sulphur effect is by far the dominant effect, although there is now some nucleation mode particle production from the other fuels; not apparent at high speed, road load.

**6.2.4. ASMO – Total surface area**

The total surface areas measured by the ASMO over the NEDC are shown in **Figure 32**.

**Figure 32** ASMO total surface area - NEDC

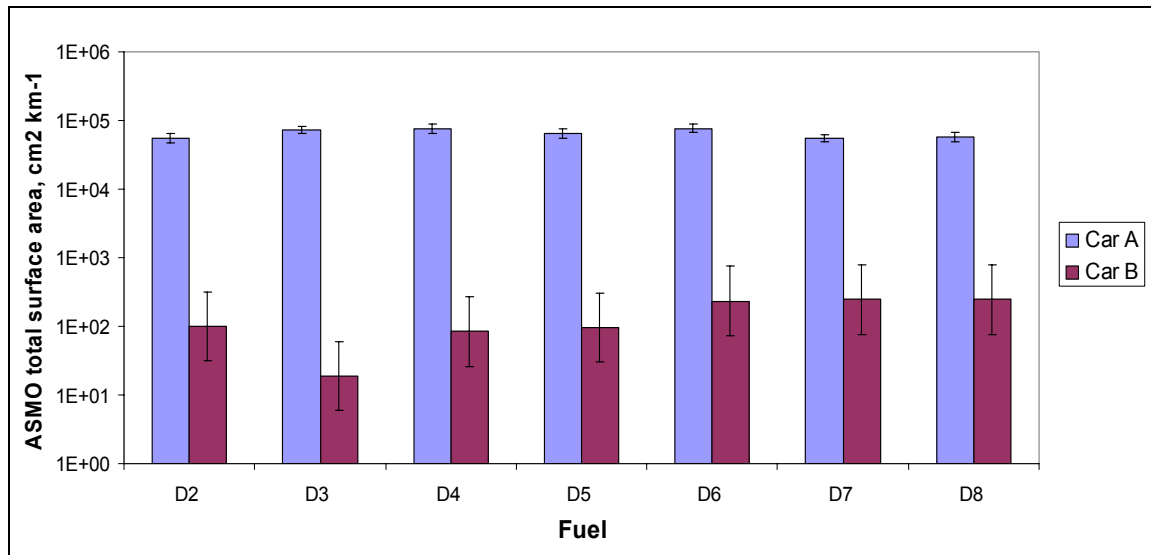

- The trap-equipped vehicle reduced the active surface area of the emitted particles by between 2-3 orders of magnitude and reflects the total particle number profile emissions as measured by the CPC (**Figure 25**).

**6.3. LIGHT-DUTY GASOLINE VEHICLES**

As discussed previously (**Section 5.2**) the data from the first test on Fuel G1 have been removed from the data analysis on both gasoline vehicles tested as these were clear outliers with respect to regulated emissions.

**6.3.1. Particulate mass**

Measurements of particulate mass have been made from the gasoline vehicles as with Diesel, despite the fact that this is not a regulated emission for gasoline vehicles. For consistency between the sections, mass is again addressed first. The figures (**Figure 33** and **Figure 34**) are plotted to the same scale as for the regulated mass emissions from the light-duty Diesel (**Figure 18**).

**Figure 33** Particulate mass - NEDC

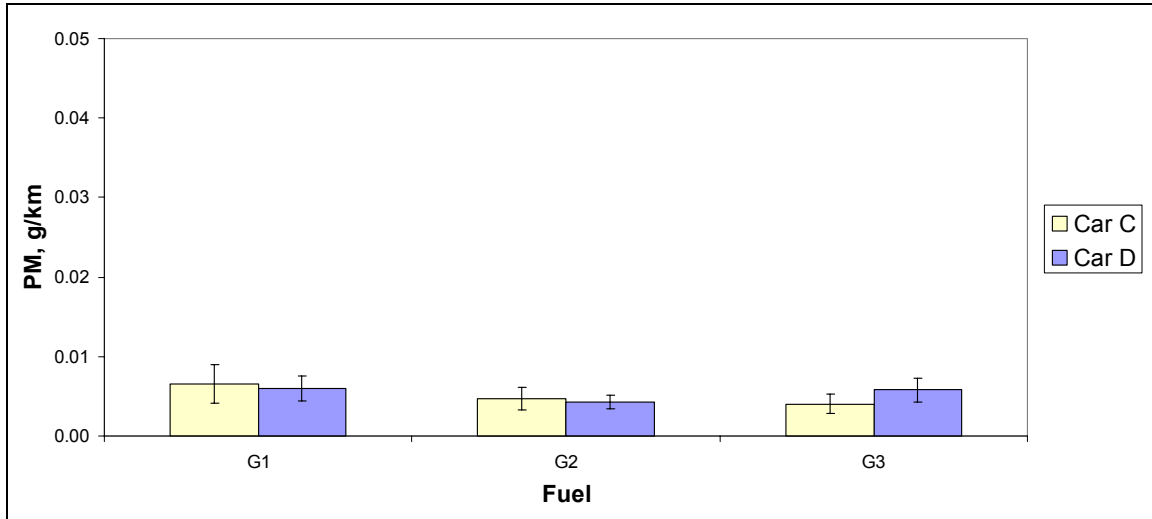

- The direct injection gasoline vehicles produced measurable amounts of particulate mass emissions over the NEDC, far below conventional diesel vehicles, but higher than trap-equipped diesels.
- There was no clear difference in particulate mass emissions between these two DI vehicles.
- There was no clear effect of gasoline sulphur content on the particulate mass emissions.

**Figure 34** Particulate mass - Artemis motorway cycle

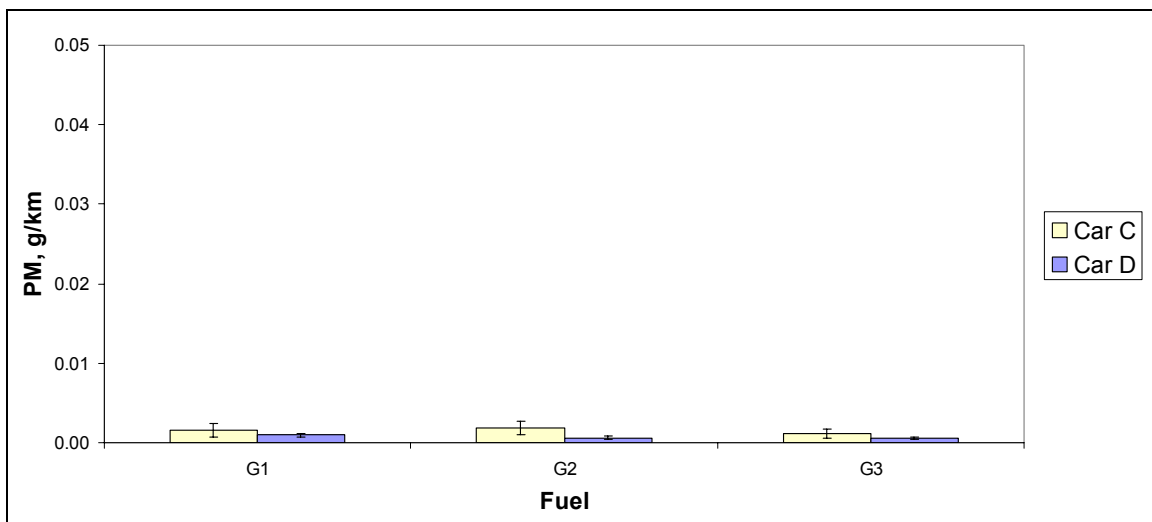

- On the Artemis motorway cycle, substantially lower particulate mass emissions were found than on the NEDC. This is consistent with the bulk of the particulate mass emissions from the DI gasoline vehicles appearing in the cold portion of the NEDC. When the engine/catalyst is warm, very little particulate mass is emitted.

### 6.3.2. Total number of carbonaceous particles

Changes in regulated particulate mass might be expected to be reflected in changes in accumulation mode (carbonaceous) particles. The ELPI combined with a thermodenuder, provides a direct measure of these carbon particles, so these data are considered next. As a result of the wide spread of data, particle number charts are shown on a logarithmic scale. **Figure 35** and **Figure 36** show the ELPI data over the NEDC and 50 km/h steady-state conditions.

**Figure 35** Total count ELPI stages 1-7 (30-1000nm) + thermodenuder, NEDC

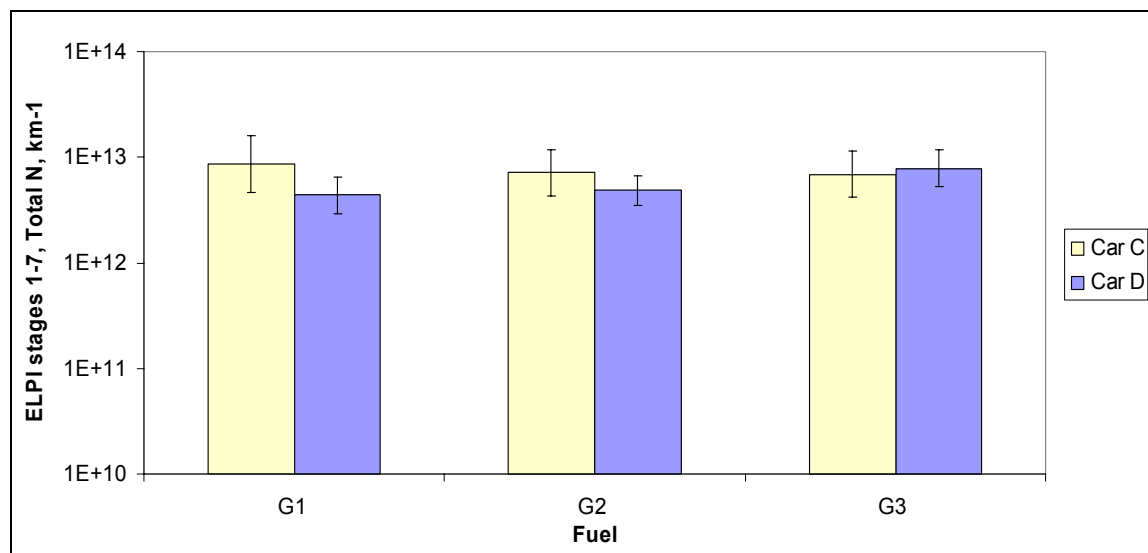

**Figure 36** Total count ELPI stages 1-7 (30-1000nm) + thermodenuder, 50km/h

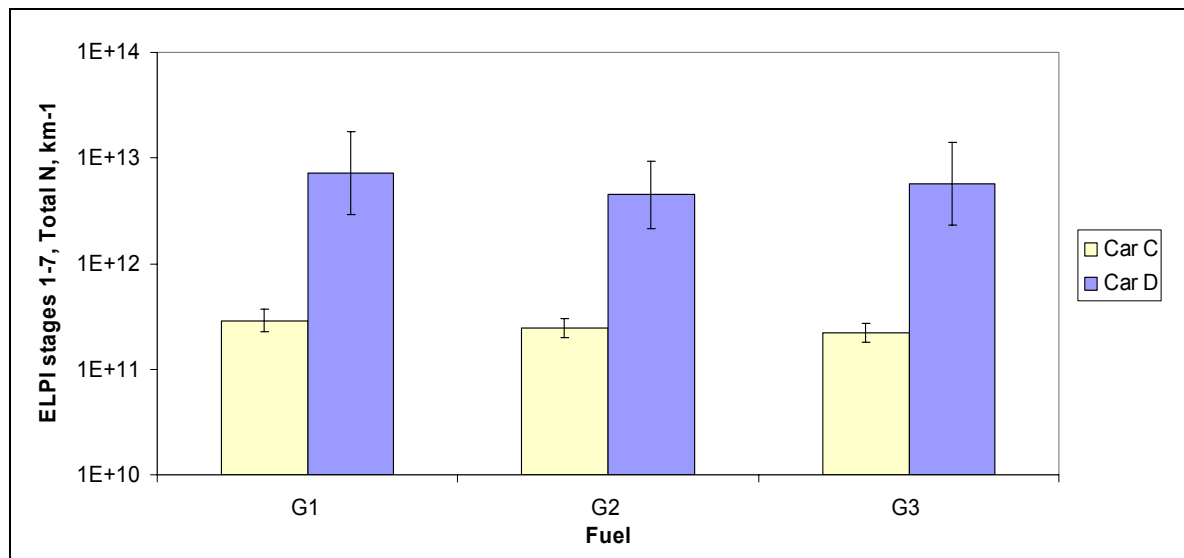

- The two cars responded differently to different test cycles in their extent of carbon particle production. Over the NEDC the two cars produced similar numbers of particles. At constant 50 km/h operation, car D produced more carbon particles than car C; this may be a result of the difference in AFR strategies.
- The number of carbon particles measured by the ELPI did not increase with increasing gasoline sulphur content.

### 6.3.3. Total particle count

#### 6.3.3.1. Transient data

For the NEDC, only the total count by the CPC is given (with no size discrimination). Over the steady-state testing, totals are given by CPC and SMPS. The SMPS totals can be split into those particles <30nm and >30nm. Absolute totals may vary and reflect the different size ranges measured by each piece of equipment.

**Figure 37** CPC total particle count - NEDC

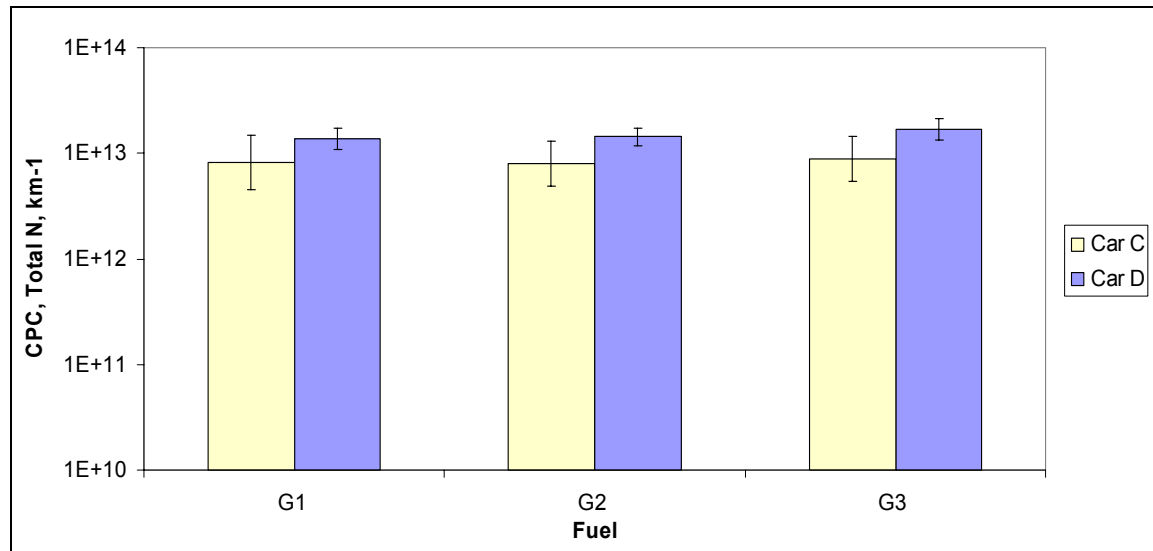

**Figure 38** CPC total particle count - Artemis motorway cycle

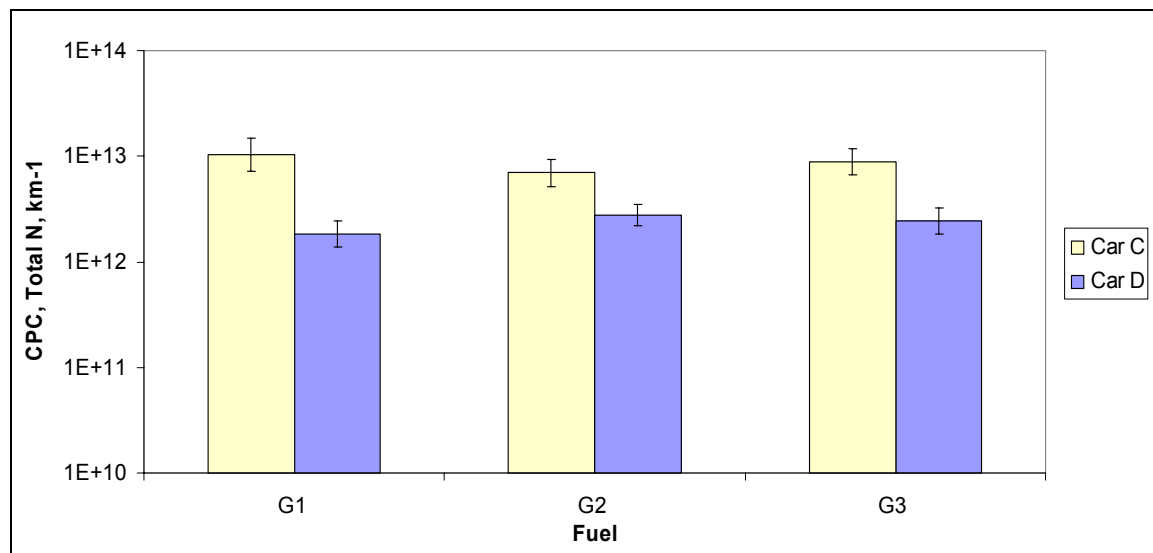

- The two cars showed similar particle number counts over the NEDC, but clear differences on the Artemis motorway cycle, where car C produced more particles than car D.
- Fuel differences were not significant and did not track increasing sulphur content.



**6.3.3.2. Steady-state Data**

As mentioned above, steady-state data allowed comparison of SMPS particles <30nm and >30nm. These are shown in **Figure 39** and **Figure 40**.

**Figure 39** SMPS particle numbers, <30 nm and >30nm: 50 km/h data

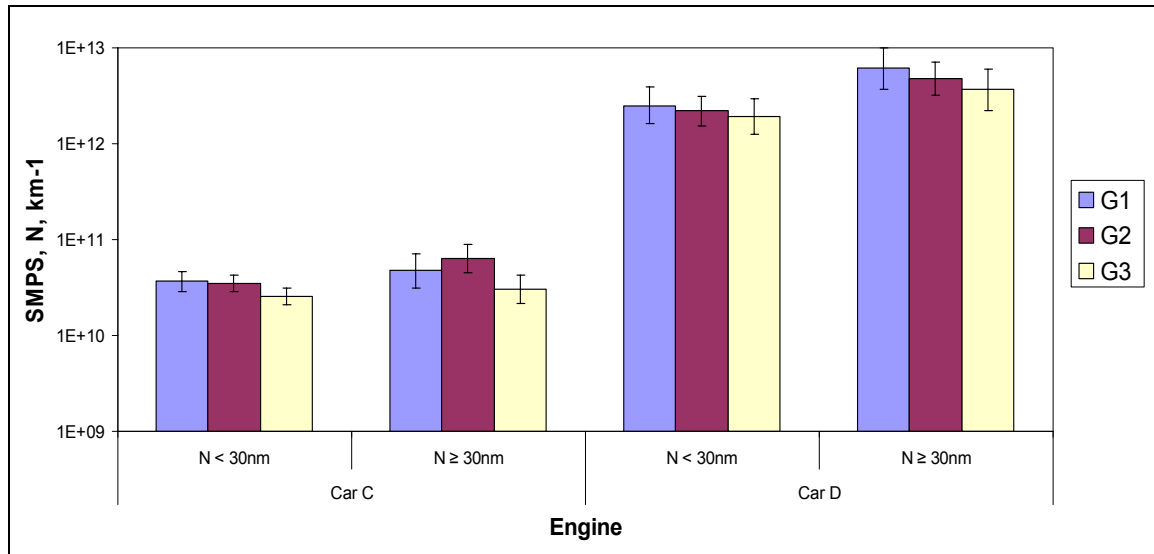

**Figure 40** SMPS particle numbers, <30nm and >30nm: 120 km/h data

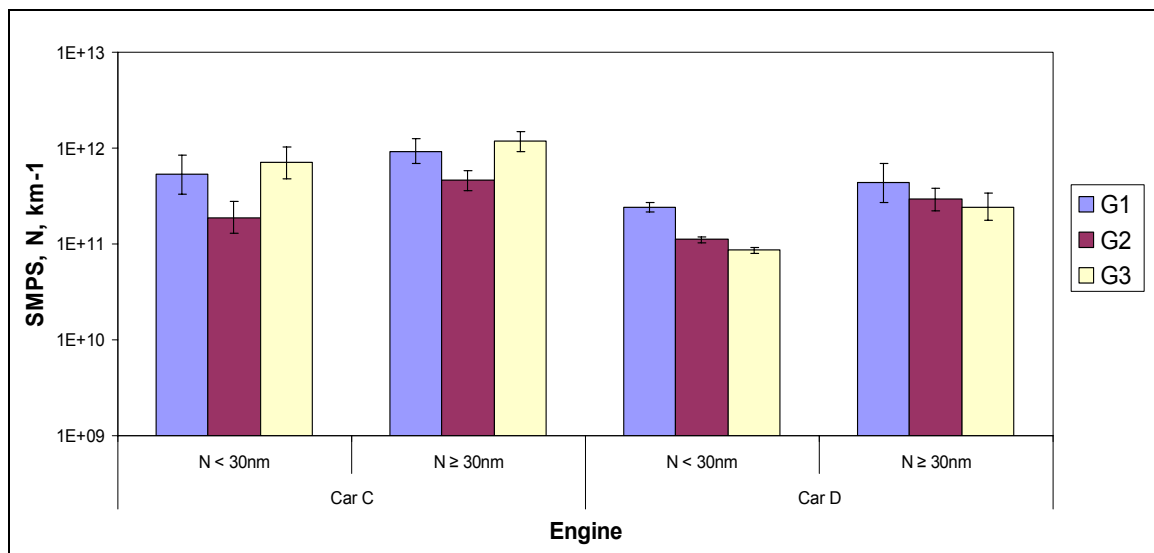

These data confirm the conclusions from the preceding sections, i.e.:

- There was no clear effect of fuel sulphur content.
- Change in speed made a large difference to the number of particles produced.

- At 50 km/h car D produced two orders of magnitude more particles than car C.
- At 120 km/h car C produced more particles than car D.

Full SMPS distributions were measured at the steady-state conditions but gave no extra information than that already seen in **Figure 39** and **Figure 40**.

In order to clarify the effects of vehicle operating conditions on particle production, the second-by-second data traces were examined for the ELPI and CPC over the NEDC and Artemis cycles and at steady-states, 50 and 120 km/h. Typical examples of these data are shown in **Figure 41**.

**Figure 41** Typical AFR and Particle number traces for the two gasoline cars operating at 50 km/h and 120 km/h

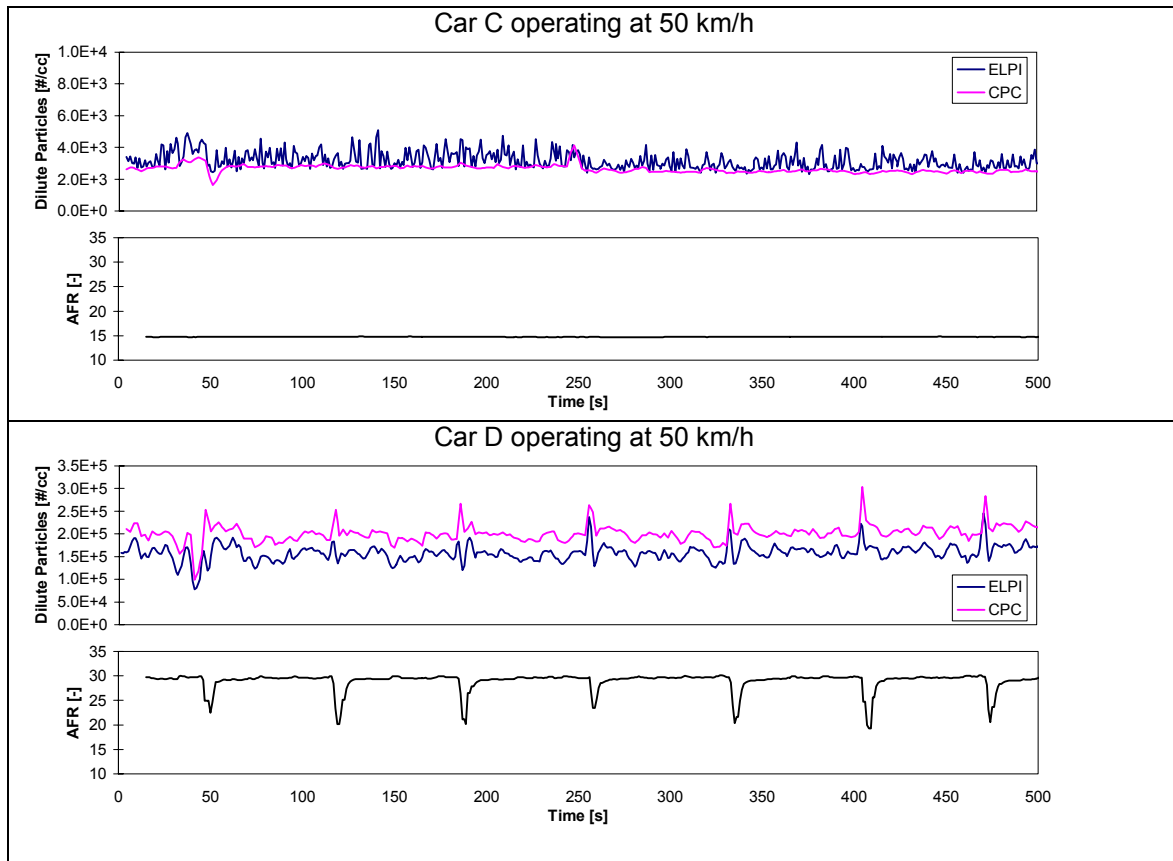

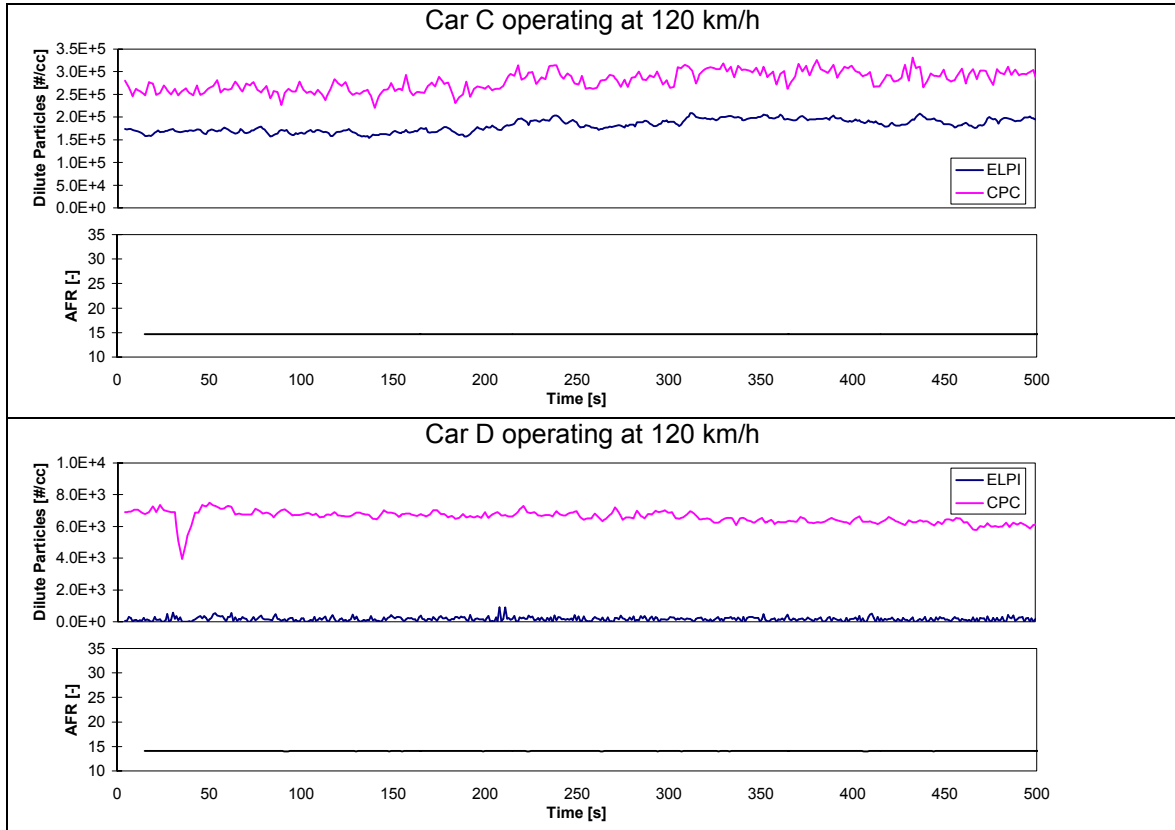

**Figure 41** demonstrates that the two vehicles have different operating strategies.

- At 50km/h car C is operating stoichiometrically whilst car D is operating under predominantly lean burn conditions and producing higher numbers of particles.
- At 120km/h both vehicles are operating stoichiometrically with car C producing higher numbers of particles than car D.
- The operating AFR strategy has a great effect on the extent of particle production [29].

#### 6.3.4. ASMO – total surface area

The surface area measured from the gasoline particles over the NEDC is shown in **Figure 42**.

**Figure 42** ASMO total surface area - NEDC

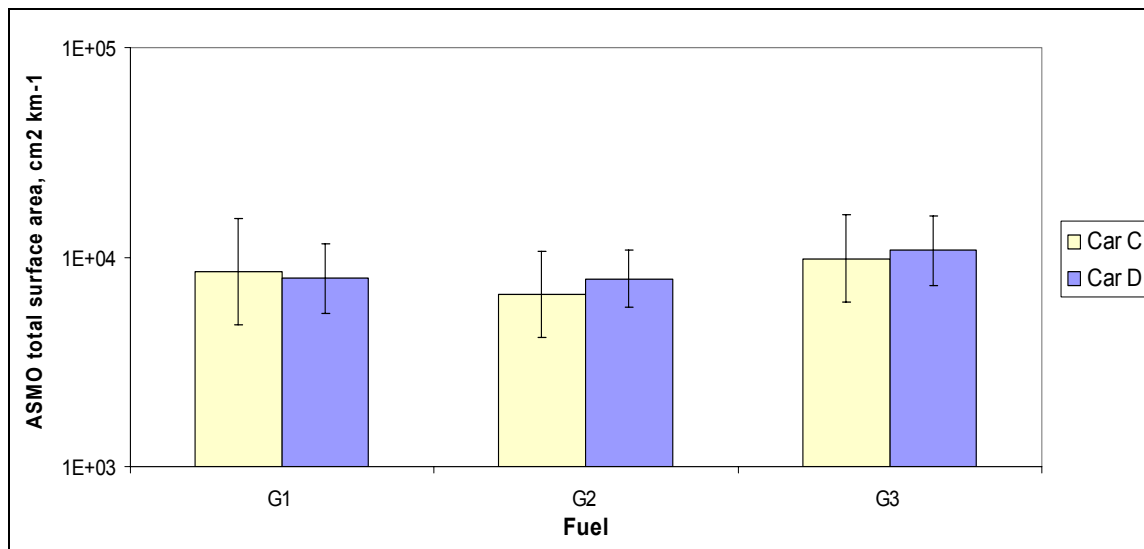

- Over the NEDC, the ASMO data showed similar trends to the CPC cycle, with the two cars giving similar results.
- The ASMO data also showed no obvious relationship with fuel sulphur content.

**6.4. INSTRUMENT REPEATABILITY**

This programme involved a wide range of particulate measurement techniques alongside the regulated mass measurement. The use of such a wide variety of analytical tools on identical test runs has enabled the precision of the different instrumentation to be compared. The precision for the heavy-duty engines is shown in **Figure 43** and for light-duty vehicles in **Figure 44**.

**Figure 43** Precision of heavy-duty particle measurements

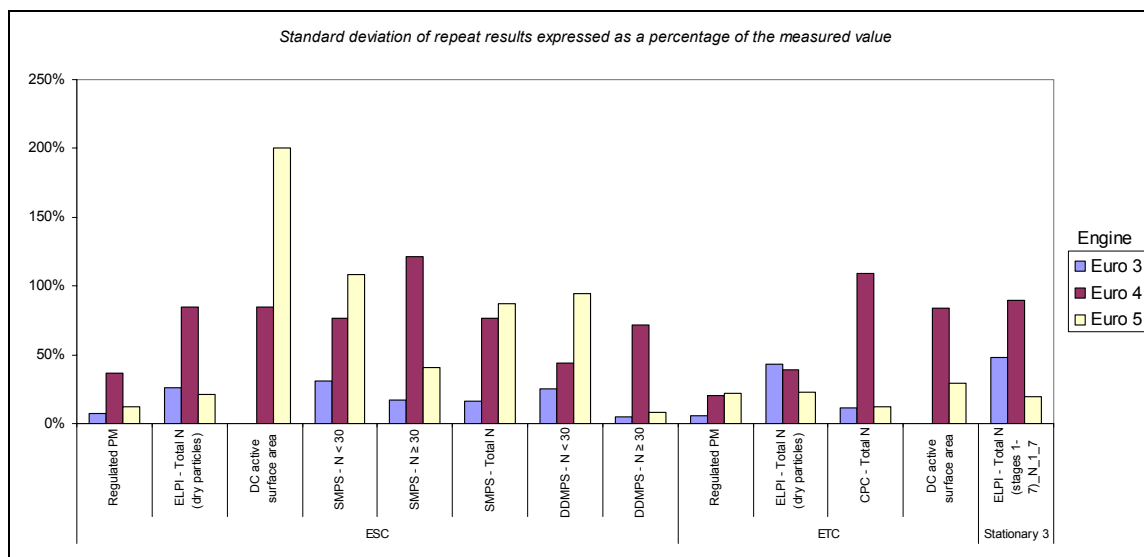

**Figure 43** shows that for heavy-duty engines, the measurement of particulate mass is still the most repeatable measurement. Because of its very low PM emissions, the repeatability of the Euro-4 engine equipped with a particle trap looks poor when expressed on this percentage scale.

**Figure 44** Precision of light-duty particle measurements

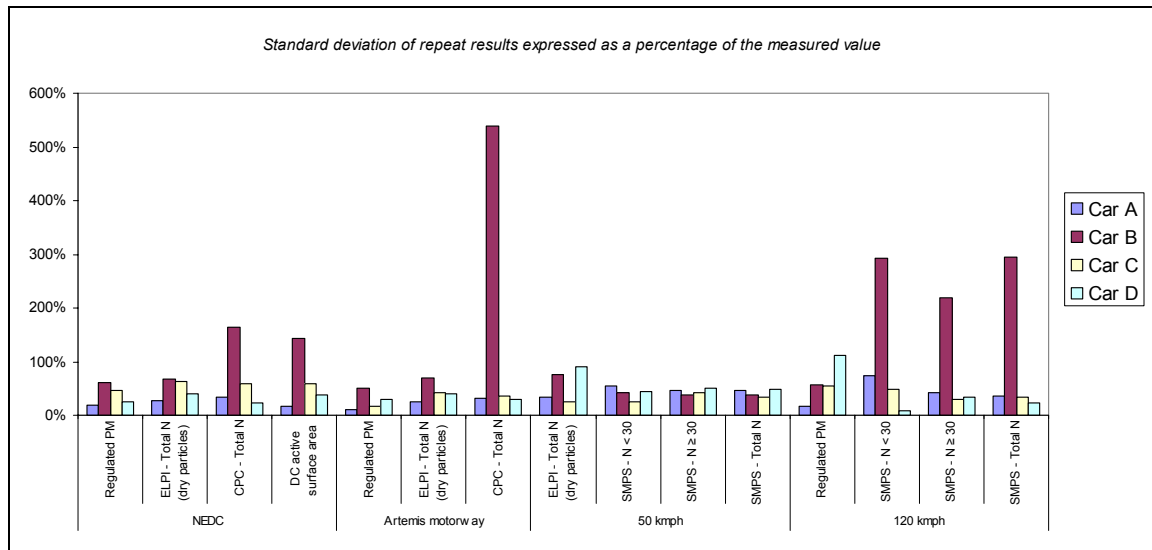

**Figure 44** includes data for both diesel and gasoline cars. It demonstrates that precision is generally poor for car B. This is due firstly to a very low base level of emissions. Secondly, the variability increases at higher temperature operating conditions, due to the increased formation of nucleation particles. Some techniques are shown to have a similar precision to the measurement of the regulated mass. DGI data was not included on this chart in view of the number of unexplained outliers.

## 7. CONCLUSIONS AND IMPLICATIONS

### *General*

- The novel particulate emission sampling and measurement system, developed under the EU DG TREN “Particulates” project, has been successfully employed to generate a comprehensive data-set on particulate mass, size and number emissions with advanced engines and fuels.
- Particle mass measurement is capable of distinguishing between engine technology levels up to DPF-equipped systems. Its continued use in regulation has the advantage of providing continuity with previous data.
- Particle number measurement techniques offer the potential for greater measurement sensitivity and discrimination, and are valuable for further research into cleaner vehicles and fuels.
- There is some evidence that the number of “solid” particles does not always correlate with mass. However, further methodology development, including definition of suitable instrument calibration procedures and multi-lab validation, would be required prior to use of “solid” particle number measurements in regulation.
- Both solid (accumulation mode) and volatile (nucleation mode) particles have been successfully measured under laboratory operation. However, nucleation mode particles are highly dependent on sampling conditions.
- Further research continues to be needed on the health relevance of measurements of “nucleation” mode particles, their chemical composition and their fate in the atmosphere.

### *Diesel*

- Engines and vehicles equipped with particulate traps produced very low particulate mass emissions, low numbers of carbonaceous particles and low total numbers of particles when operating on low sulphur fuels.
  - This represents a bigger step than the changes from Euro-1 to Euro-3.
- A heavy-duty prototype Euro-5 engine equipped with SCR/urea, but without a particle trap, produced very low particulate mass, within the Euro-5 limits, but its particle number emissions were considerably higher than the trap-equipped option.
- The effect of diesel fuel sulphur was greatest under high temperature operation. Under these conditions, fuels with nominal 50ppm or lower sulphur reduced particle mass and number emissions.
- 300ppm sulphur fuels with widely different fuel compositions gave similar emissions.
- In the advanced engine technologies, fuel effects other than sulphur on particulate emissions were small in absolute terms.
- The addition of 5% RME to a base fuel made little difference to particulate emissions levels.

***Gasoline***

- Direct injection gasoline cars produced measurable amounts of particulate mass emissions over the NEDC, well below the Euro-4 diesel emissions limit, but higher than a trap-equipped diesel car.
- This was reflected in the numbers of carbonaceous and total particles.
- There was no clear short-term effect of gasoline sulphur content on the particulate emissions from direct injection gasoline vehicles.
- Engine speed and operating strategy seem important to total particle number emissions from DI gasoline cars.

## 8. GLOSSARY

ANOVA	Analysis of Variance
ASMO	Active Surface Area Measurement (Diffusion Charger)
CADC	Common Artemis Driving Cycles
CFPP	Cold Filter Plugging Point
COV	Coefficient of Variation (defined as standard deviation of sample over mean)
CPC	Condensation Particle Counter
CR	Compression Ratio
CRT	Continuously Regenerative Trap
CVS	Constant Volume Sampling System
DC	Diffusion Charger (see ASMO)
DDMPS	Dual Differential Mobility Particle Sizer
DGI	Gravimetric Impactor
DI	Direct Injection
DISI	Direct Injection Spark Ignition
DPF	Diesel Particulate Filter
DVPE	Dry Vapour Pressure Equivalent
ECE	Urban driving part of the NEDC
EGR	Exhaust Gas Recirculation
ELPI	Electrical Low Pressure Impactor
EPEFE	European Programme on Emissions, Fuels and Engine Technologies
ESC	European Steady-state Cycle
ETC	European Transient Cycle
EU	European Union
EUDC	Extra Urban Drive Cycle



FAME	Fatty Acids Methyl Ester
FIE	Fuel Injection Equipment
FT	Fischer-Tropsch (diesel)
HD	Heavy-duty
HFRR	High Frequency Reciprocating Rig (diesel fuel lubricity test)
KV40	Kinematic Viscosity at 40°C
LD	Light-duty
LHV	Lower Heating Value
NEDC	New European Driving Cycle
PM	Particulate Mass
RME	Rapeseed Methyl Ester
SCR	Selective Catalytic Reduction (using urea)
SE	Standard Error
Significant	Statistically significant at >95% confidence
SMPS	Scanning Mobility Particle Sizer
TC	Turbo Charged
TD	Thermodenuder
TrDMPS	Transient Differential Mobility Particle Sizer
T10	Temperature (°C) at which 10% v/v fuel is recovered
T50	Temperature (°C) at which 50% v/v fuel is recovered
T95	Temperature (°C) at which 95% v/v fuel is recovered

## 9. ACKNOWLEDGEMENTS

CONCAWE would like to acknowledge the following organisations for their contributions to this work:

- AVL List GmbH Graz, Austria for running the heavy-duty engine tests.
- Shell Global Solutions for running the light-duty vehicle tests.
- BP Global Fuels Technology, Shell Global Solutions and Total for provision of test fuels.
- Shell Global Solutions for statistical support.
- DG TREN “Particulates” consortium partners for their collaboration in this field.

## 10. REFERENCES

1. CONCAWE (2005) Fuel effects on emissions from advanced diesel engines and vehicles. Report No. 2/05. Brussels: CONCAWE
2. EU (2000) Characterisation of exhaust particulate emissions from road vehicles. DG TREN contract number 2000-RD.11091. Brussels: European Commission  
<http://vergina.eng.auth.gr/mech/lat/particulates/>
3. Thompson, N. et al (2004) Fuel effects on regulated emissions from advanced diesel engines and vehicles. SAE Paper No. 2004-01-1880. Warrendale PA: Society of Automotive Engineers
4. EU (1998) Directive 98/69/EC of the European Parliament and of the Council of 13 October 1998 relating to measures to be taken against air pollution by emissions from motor vehicles and amending Council Directive 70/220/EEC. Official Journal of the European Communities No. L350, 28.12.1998
5. EU (2000) Directive 1999/96/EC of the European Parliament and of the Council of 13 December 1999 on the approximation of the laws of the Member States relating to measures to be taken against the emission of gaseous and particulate pollutants from compression ignition engines for use in vehicles, and the emission of gaseous pollutants from positive ignition engines fuelled with natural gas or liquefied petroleum gas for use in vehicles and amending Council Directive 88/77/EEC. Official Journal of the European Communities No. L44, 16.02.2000
6. Andersson, J. and Wedekind, B. (2001) DETR/SMMT/CONCAWE Particulate research programme 1998-2001 - Summary report. Report No. DP01/0515. Shoreham-by-Sea: Ricardo Consulting Engineers Ltd
7. EU (2000) Assessment and reliability of transport emission models and inventory systems (ARTEMIS). DG TREN contract number 1999-RD.10429, coordinated by TRL Ltd. Brussels: European Commission <http://www.trl.co.uk/artemis/>
8. Ntziachristos, L. et al (2004) Overview of the European "Particulates" Project on the characterization of exhaust particulate emissions from road vehicles: results for light-duty vehicles. SAE Paper No. 2004-01-1985. Warrendale PA: Society of Automotive Engineers
9. Thompson, N. et al (2004) Overview of the European "Particulates" project on the characterization of exhaust particulate emissions from road vehicles: results for heavy-duty engines. SAE Paper No. 2004-01-1986. Warrendale PA: Society of Automotive Engineers
10. Marsh, G. et al (2000) Consultation on the need to reduce the sulphur content of petrol and diesel fuels below 50 ppm: - a policy makers summary. Harwell: AEA Technology Environment
11. EU (2003) Directive 2003/17/EC of the European Parliament and of the Council of 3 March 2003 amending Directive 98/70/EC relating to the quality of petrol and diesel fuels. Official Journal of the European Communities No. L76, 22.03.2003

- 
12. EU (2001) Characterisation of exhaust particulate emissions from road vehicles. Deliverable 5: Definition of the detailed measurement matrix for the production of representative emissions factors. DG TREN PARTICULATES Consortium. Brussels: European Commission
  13. Kittelson, D. et al (2002) Diesel aerosol sampling methodology - CRC E-43. Final Report. Alpharetta GA: Coordinating Research Council
  14. EU (2002) Characterisation of exhaust particulate emissions from road vehicles. Deliverable 3, Part I: Investigations for the definition of sampling conditions for the selected instrumentation. DG TREN PARTICULATES Consortium. Brussels: European Commission
  15. EU (2001) Characterisation of exhaust particulate emissions from road vehicles. Deliverable 3, Part II: Relevant protocol for particulate characterisation. DG TREN PARTICULATES Consortium. Brussels: European Commission
  16. Ntziachristos, L. et al (2004) Performance evaluation of a novel sampling and measurement system for exhaust particle characterization. SAE Paper No. 2004-01-1439. Warrendale PA: Society of Automotive Engineers
  17. CONCAWE (2001) Measurement of the number and mass weighted size distributions of exhaust particles emitted from European heavy duty engines. Report No. 01/51. Brussels: CONCAWE
  18. Graskow, B.R. (2001) Design and development of a fast aerosol size spectrometer. Cambridge: University of Cambridge, Department of Engineering
  19. EPEFE (1995) European programme on emissions, fuels and engine technologies. EPEFE Report on behalf of ACEA and EUROPIA
  20. Wedekind, B. et al (2000) DETR/SMMT/CONCAWE particle research program: heavy-duty results. SAE Paper No. 2000-01-2851. Warrendale PA: Society of Automotive Engineers
  21. Hochhauser, A.M. et al (1991) The effects of aromatics, MTBE, olefins and T90 on mass exhaust emissions from current and older vehicles - the auto/oil air quality improvement research program. SAE Paper No. 912322. Warrendale PA: Society of Automotive Engineers
  22. Painter, L.J. and Rutherford J.A. (1992) Statistical design and analysis methods for the auto/oil air quality research program. SAE Paper No. 920319. Warrendale PA: Society of Automotive Engineers
  23. CONCAWE (1994) The influence of heavy gasoline components on the exhaust emissions of European vehicles. Part 1 - regulated emissions. Report No. 94/59. Brussels: CONCAWE
  24. CONCAWE (2002) Evaluation of diesel fuel cetane and aromatics effects on emissions from euro-3 engines. Report No. 4/02. Brussels: CONCAWE
  25. CONCAWE (2003) Fuel effects on emissions from modern gasoline vehicles. Part 1 - sulphur effects. Report No. 5/03. Brussels: CONCAWE

26. CONCAWE (2004) Fuel effects on emissions from modern gasoline vehicles. Part 2 - aromatics, olefins and volatility effects. Report No. 2/04. Brussels: CONCAWE
27. CONCAWE (1998) A study of the number, size & mass of exhaust particles emitted from European diesel and gasoline vehicles under steady-state and European driving cycle conditions. Report No 98/51. Brussels: CONCAWE
28. Hall, D.E. and Dickens, C.J. (2000) Measurement of the numbers of emitted gasoline particles: genuine or artefact? SAE Paper No. 2000-01-2957. Warrendale PA: Society of Automotive Engineers
29. Hall, D.E. and Dickens, C.J. (1999) Measurement of the number and size distribution of particles emitted from a gasoline direct-injection vehicle. SAE Paper No. 1999-01-3530. Warrendale PA: Society of Automotive Engineers
30. Barnett, V. and Lewis, T. (1994) Outliers in statistical data, 3<sup>rd</sup> edition. New York: John Wiley & Sons Ltd

**APPENDIX 1 ARTEMIS “REAL WORLD” DRIVE CYCLES**

**Figure A.1.1**

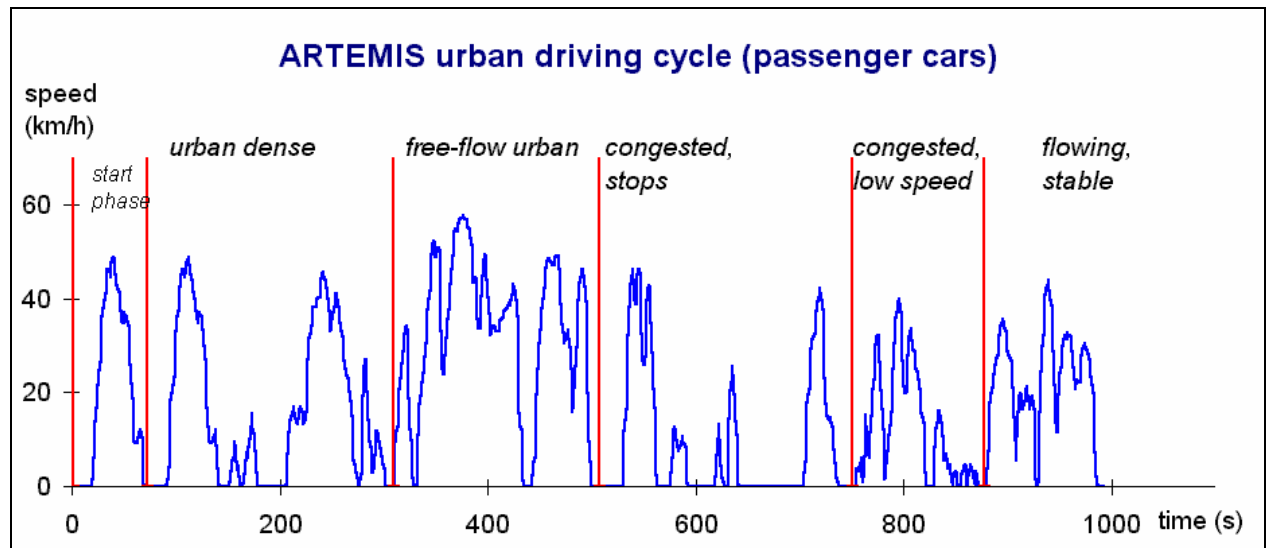

**Figure A.1.2**

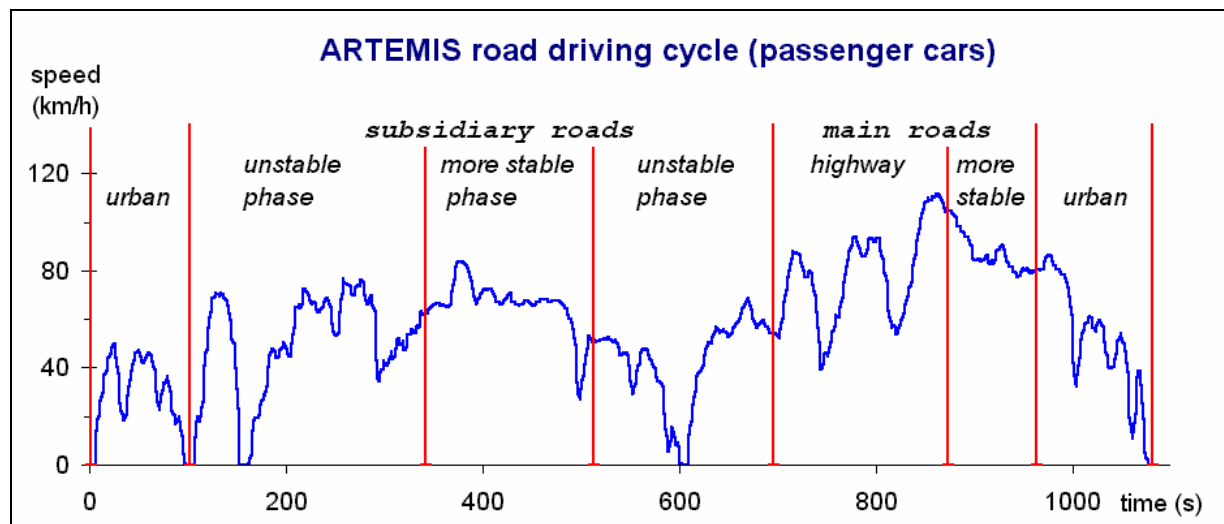
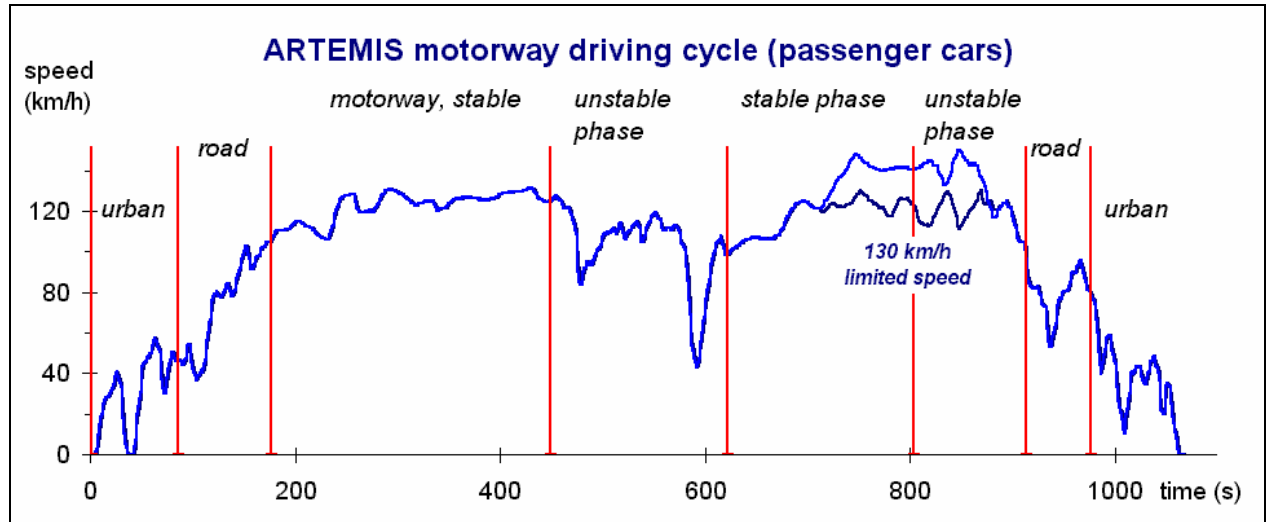

Figure A.1.3



## APPENDIX 2 MEAN EMISSIONS DATA, GASOLINE CARS

Cycle	Car	Fuel	CO (g/km)	NOx (g/km)	HC (g/km)	CO <sub>2</sub> (g/km)	PM (g/km)
<b>NEDC</b>	<b>C</b>	<b>G1</b>	0.192	0.0417	0.0948	177.5	0.00652
<b>NEDC</b>	<b>C</b>	<b>G2</b>	0.163	0.0432	0.0901	176.4	0.00473
<b>NEDC</b>	<b>C</b>	<b>G3</b>	0.162	0.0347	0.0925	176.3	0.00405
<b>NEDC</b>	<b>D</b>	<b>G1</b>	0.621	0.0248	0.1312	202.8	0.00601
<b>NEDC</b>	<b>D</b>	<b>G2</b>	0.591	0.0202	0.1225	202.3	0.00428
<b>NEDC</b>	<b>D</b>	<b>G3</b>	0.604	0.0211	0.1244	201.3	0.00577
<b>Motorway</b>	<b>C</b>	<b>G1</b>	0.320	0.0291	0.0110	151.4	0.00154
<b>Motorway</b>	<b>C</b>	<b>G2</b>	0.161	0.0256	0.0053	151.5	0.00179
<b>Motorway</b>	<b>C</b>	<b>G3</b>	0.199	0.0235	0.0033	151.0	0.00113
<b>Motorway</b>	<b>D</b>	<b>G1</b>	1.664	0.0100	0.0369	193.1	0.00093
<b>Motorway</b>	<b>D</b>	<b>G2</b>	1.578	0.0060	0.0134	192.7	0.00064
<b>Motorway</b>	<b>D</b>	<b>G3</b>	3.137	0.0071	0.0210	193.6	0.00058

Note: Mean emissions data for light-duty diesel vehicles and heavy-duty diesel engines can be found in the companion CONCAWE report on the regulated emissions [1].



### APPENDIX 3 STATISTICAL DATA ANALYSIS

This appendix provides additional information on the data handling and statistical analysis methods discussed in **Section 5**.

#### *Studentized residuals*

The data were examined for possible outliers and trends by examining studentized residuals (residuals divided by their standard errors) in analysis of (co)variance models fitted to the measured emissions for a particular vehicle (or engine) and cycle on either the original and/or log-transformed scale (or both) as appropriate. The studentized residuals were compared against the upper 5% and 1% points tabulated in [30]. Suspicious results were queried with the originating laboratory and were not rejected unless there were sound engineering reasons to believe that something untoward had happened in that particular test.

#### *Arithmetic and geometric means*

In the bar charts in **Section 6**, arithmetic means are used for particulate mass and geometric (i.e. logarithmic) means for particle numbers and surface area. Geometric means give excellent comparisons between fuels on a percentage basis but have the disadvantage of underestimating total emissions to the atmosphere. Arithmetic means give better estimates of total emissions to the atmosphere but can be inflated unduly by isolated high results.

Geometric means cannot be calculated when there are zero or negative values in the data. This problem can be overcome by adding an offset  $B$  and calculating the *offset geometric mean*

$$\text{OGM}(y_1, y_2, \dots, y_n) = \exp\left(\frac{\ln(y_1 + B) + \ln(y_2 + B) + \dots + \ln(y_n + B)}{n}\right) - B$$

Each vehicle/engine  $\times$  cycle  $\times$  emission-measurement data set was analysed separately. The standard errors of the arithmetic mean emissions for the various fuels were estimated from a weighted analysis of variance in which each emission measurement was assigned a weight equal to

$$\text{weight} = 1 / (\text{mean emission for that fuel and vehicle})^2$$

to take account of the lognormality in the data (see [19], Annex 05). These standard errors are then multiplied by the appropriate percentile of  $t$ -distribution to derive confidence limits for the true mean, e.g.

$$\text{arithmetic mean} - t \times \text{SE} < \text{true mean} < \text{arithmetic mean} + t \times \text{SE}$$

Confidence limits about geometric means are calculated by performing unweighted ANOVAs on log(emissions), thereby calculating means, standard errors and confidence limits on the logarithmic scale. The upper and lower limits can then be transformed back to the original scale.

In the bar charts presented in **Section 6**, the error bars show the

$$\text{mean value} \pm 1.4 \times \text{standard error of mean}$$

The factor 1.4 was chosen for consistency with both the EPEFE [19] and recent CONCAWE reports [24-26]. The original rationale was that when two fuels were significantly different from one another at  $P < 5\%$ , their error bars would not overlap; this factor also gave 84% confidence that the true mean lay within the limits shown.

Error bars based on a factor 1.4 err on the side of being slightly too narrow for determining significant differences in the present programme as fewer tests were carried out. Such an interpretation would require error bars based on factors in the region of 1.5 to 1.6 for diesel and 1.7 to 1.8 for gasoline, depending on the exact number of valid tests.

In some tests, two ETC measurements were made within a short time of one another. These were averaged before computing the overall mean. For example, if two measurements were taken in the first test, one in the second and one in the third, then the overall mean would be

$$\text{Overall mean} = \frac{(\text{Test 1 Result 1} + \text{Test 1 Result 2}) / 2 + \text{Test 2 Result} + \text{Test 3 Result}}{3}$$

Proper account has been taken of the different levels of variation between back-to-back and long repeat when calculating standard errors (see annex 05 of the EPEFE report [19]).

### **Units**

The measurement intervals used by the various analysers when measuring particle number or mass distributions are of very different widths. Therefore emission measurements are usually normalised to what they would have been had the measurement interval been 1 unit in width on a  $\log_{10}$  scale. By convention, the notation  $dN/d\log_{10}d_p$  is used to describe the units of such measurements. Values of  $dN/d\log_{10}d_p$  are usually plotted on a log scale on the vertical axis<sup>3</sup>. The particle sizes  $d_p$  are always plotted on a log scale on the horizontal axis.

---

<sup>3</sup> The notation is mathematically correct only if  $N$  is regarded as the total number of emitted particles smaller than or equal to  $d_p$  in diameter.